

TS 2301

.P3 P4

1971







The PHONOGRAPH

and How to Use It

BEING A SHORT HISTORY OF ITS
INVENTION AND DEVELOPMENT
CONTAINING ALSO DIRECTIONS
HELPFUL HINTS AND PLAIN TALKS
AS TO ITS CARE AND USE, ETC.

*Including also a Reprint of the
Openeer Papers and Phonograph Short Stories*

Three Greek Roots

What Mr. Openeer Heard

How We Gave a Phonograph Party

The Secret of Making Phonograph Records

The Phonograph as an Aid to Language Study

The Phonograph as an Aid to the Arts of Stenography
and Typewriting

SET INTO TYPE AND IMPRINTED IN NEW YORK IN
THE YEAR M · D · C · C · C · C

TWO COPIES RECEIVED.

Library of Congress,
Office of the

MAR 2 - 1900

Register of Copyrights.

TS 2301
P3 PA
1971

55954



Copyright 1900, by
THE NATIONAL PHONOGRAPH COMPANY
All Rights Reserved



6-1735

SECOND COPY,

1829

Jan. 20. 1900

TS 2301
P3 PA
1971

TABLE OF CONTENTS.

PART FIRST.—THE PHONOGRAPH.

CHAPTER I. History—Ancient, Medieval and Modern,	11
CHAPTER II. Prophecy,	15
CHAPTER III. More Modern History,	20
CHAPTER IV. The Story of the Invention,	23
CHAPTER V. The First Phonograph,	25
CHAPTER VI. Pictorial and Commercial History,	27

PART SECOND.—HOW TO USE IT.

INTRODUCTION,	41
CHAPTER I. The Gem,	46
CHAPTER II. The Standard,	51
CHAPTER III. The Home,	60
CHAPTER IV. The Spring Motor,	68
CHAPTER V. The Concert,	78
CHAPTER VI. The "M" and "E" Electric,	80
CHAPTER VII. The "M" Concert,	91
CHAPTER VIII. The "H" Coin Slot,	93
CHAPTER IX. The "M" Coin Slot,	103
CHAPTER X. The "M" Concert Coin Slot,	105
CHAPTER XI. Batteries,	109
CHAPTER XII. Repeating Attachment,	116
CHAPTER XIII. Blanks and Records,	118
CHAPTER XIV. Shaving,	122
CHAPTER XV. Dictating,	124
CHAPTER XVI. Speakers,	127
CHAPTER XVII. A Word about Belts,	131

PART THIRD.—THE OPENEER PAPERS.

CHAPTER I. What Mr. Openeer Heard,	135
CHAPTER II. How We Gave a Phonograph Party,	145
CHAPTER III. The Secret of Making Phonograph Records,	152
CHAPTER IV. The Phonograph as an Aid to Language Study,	160
CHAPTER V. The Phonograph as an Aid to the Arts of Stenography and Typewriting,	166
CHAPTER VI. Three Greek Roots,	177

PART FIRST

THE PHONOGRAPH

FOREWORD

Much has been written concerning the Phonograph since Thomas A. Edison startled the world with the first tin foil machine, a round generation ago. The history of its development, step by step would fill volumes. The earlier types have become obsolete in the march of progress. It is the purpose of this book to illustrate and describe, not only the first distinctly practical Phonograph of Commerce (the type M Electric Phonograph) but all the subsequent types and styles; together with the various attachments which are now in everyday use.

What with the diagrams and the plain instructions, it will be demonstrated that the Phonograph is as easy to take care of and as simple to manage as any mechanical movement that is thoroughly understood by its operator.

[E.D.]

CHAPTER I.—HISTORY.

ANCIENT.

FROM the beginning of Time, man's mind has sought to reproduce by mechanical means, the sounds of the Living World. Of the great antiquity of musical instruments there are many evidences ; but the first attempt to simulate the

human voice is doubtless the wonderful statue of Memnon at Thebes, dating back to the 18th Egyptian Dynasty, B. C. 1490. Two colossal statues still stand on the west bank of the Nile, near the present village of Karnak, 'mid the ruins of some eighteen others. At one time, the most northern gave forth sounds at sunrise, supposed to be Memnon's morning sa-

lute to his mother Eos, the Goddess of Dawn. That this is more than a mere fable seems to be attested by several cuniform inscriptions on the base of the statue, placed there by famous travellers. The statue was tumbled over by an earthquake in B. C. 27. Strabo, one of the earliest globe trotters on record, visited Memnon in the year 7 A. D., and writes rather cautiously of the voice, calling it merely a noise. Other writers (among them Tacitus, recording the visit of the Roman General Germanicus A. D. 79)

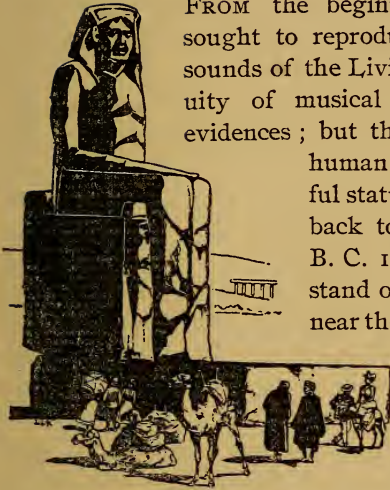

refer to the sound as distinctly musical; while still other enthusiastic writers dignify it as a song. Among the notables whose visits to the statue are recorded, are Titus Petronius Secundus, a Roman Prefect, A. D. 82, and the Emperors Hadrian, A. D. 140, and Septimius Severus, A. D. 194.

Several of the inscriptions (the earliest dating A. D. 65) express or imply the idea that Memnon when entire, could speak in language; but since his mutilation was reduced to inarticulate sounds. The best of the lot is by one Asklepiodotus, the imperial procurator: "Know, O sea-born Thetis, that Memnon could not die. When the hot rays shed by his mother [Eos] fell brightly upon him, his clear song rings out while the Spreading Nile parts the Lybian hills from hundred gated Thebes."

The statue was restored A. D. 196, by Septimius Severus, soon after his visit; but alas! the wonderful gift of speech had departed.

MEDIEVAL.

During the next ten centuries, there are instances without number of talking automatons that have been genuinely constructed to perform mechanical wonders, but the voices have been produced by trickery; either a concealed person has talked through tubes or by echo from a concealed position.

The first *authentic* talker appeared in the 13th century, when Friar Roger Bacon, the early English Philosopher, constructed an ingenious talking head.

Gerber, a German Monk of an earlier period than Bacon, is said to have made a most wonderful brazen head that talked, as did also Albertus Magnus; but there is so much that is legendary interwoven in the records that all but Bacon's head may be fairly put down as fables. Bacon's talking machine was doubtless suggested by the Speaking Head of Orpheus, which was an awe inspiring enigma to the early Greeks; but it is more than probable

that this wonder was to be accounted for on the same principle as the vocal power of the colossal statue of the Indian God, Siva (the Destroyer) where a seat was provided for a priest under the headgear of the figure. In the case of Memnon however, it is generally conceded that the sounds were due to some artifice of construction or peculiarity of material used rather than the deception of priests; thus establishing it as the first talking statue. The same may be said of Bacon's head. Its verity is vouched for by early testimony, thus establishing it without doubt as the first talking automaton.

MODERN.

From Bacon to Faber of the present time is a long step, with no great achievement to chronicle, unless we except the famous duck of Vaucanson, so often referred to as one of the mechanical wonders of the century. This was constructed in 1740, and astonished all beholders by not only quacking in a life-like manner, but by waving its wings, pluming its feathers, eating grain and even digesting its food. The crowning point of mechanical ingenuity was reached by Herr Faber, a Vienna experimenter, who in 1860 built a most elaborate talking man, which easily stands at the head of all talking machines of the automaton class.

A brief description of Faber's talking man may be of interest. It has flexible lips of rubber, and also a rubber tongue, ingeniously controlling vowels and consonants. In its throat is a tiny fan wheel, by which the letter 'r' is rolled. It has an ivory reed for vocal cords. Its mouth is an oval cavity, the size of which is regulated by sliding sections, rapidly operated from a key-board. A tube is attached to its nose when it speaks French. It is really a most wonderful piece of mechanism, but a hundred times more complicated than Mr. Edison's Phonograph of 1887, or the perfected Phonograph of to-day.

But Faber and his predecessors were on the wrong track in

attempting to solve the problem of sound reproduction in this manner, on its physical side. Faber sought a cause; Edison saw an effect, and said, "The Thing is there, it has but to be found." Faber started from the *source* of the sound, and built a mechanism, reproducing the *causes* of the vibrations that made articulate speech. It remained for Edison to start from the vibrations; to obtain the mechanical *effects* of such vibrations; to record them on a pliable material and then to reproduce them.

Faber copied the movements of the vocal organs, Edison studied a vibrating diaphragm, and reproduced the action of the ear drum when acted upon by the vibration *caused* by the vocal organs.

The reader whose interest has been aroused and who desires more complete and detailed information concerning this and succeeding chapters can consult the following authorities with profit. [Ed.]

- George Ebers, *Egypt*, Vol. 2, pp. 268-272.
- George Rawlinson, *Story of Ancient Egypt*, pp. 210-216.
- J. A. Setronne, *The Quarterly Review*, 1875.
- George B. Prescott, *The Electric Telephone*.
- Count du Moncel, *The Microphone and the Phonograph*.
- Thomas A. Edison, *North American Review*, 1878.
- Thomas A. Edison, *North American Review*, 1888.
- Geo. P. Lathrop, *Harper's Monthly*, 1890.
- Chas. D. Lanier, *Review of Reviews*, 1893.
- Johnson's *Encyclopedia*.
- Encyclopedia Britannica*.
- Groves *Dictionary of Music*.

CHAPTER II.—PROPHECY.

LET us now step into the realms of literature, and note what has been written of the Phonograph in the line of prophecy; if indeed such fanciful predictions and visionary foreshadowings as we shall quote can be justly termed prophetic. Yet all prophecies are but vague foreseeings. To-day we are speculating on human flight and ultra rapid transit *in vacuo*. We are guessing and experimenting at many problems which may become realities at any moment. Seeing by telephone is almost accomplished, and wireless telegraphy is a fact. The unknown of to-day may be known to-morrow. Fact springs from Fancy in the Present; as it has in the Past, and as it will in the Future. So listen!

John Wilkins, Bishop of Chester, who died in London in 1672, was an accomplished theologian, scientist, mathematician and physicist. In his work on *Mathematic Magick* (1651), he says: "Some have thought it possible to preserve the voice, or any words spoken, in a hollow trunk or pipe, so when this pipe is rightly opened the words will come out of it in the same order wherein they were spoken."

This is perhaps a very rough anticipation of the Phonograph. To charge a tube with words, as a cannon is loaded with powder and shot, beforehand, to be rattled out like the frozen up tunes in Baron Munchausen's trumpet when a thaw came—it was certainly a most original theory.

Again listen!

In 1620-1655 there lived a French poet and philosopher, by name Savinien Cyrano de Bergerac, whose fame has been but recently refurbished by the playhouse and M. Rostand. In 1656, a year after his death, there was published his "Histoire Comique en Voyage dans la Lune," a manuscript written in 1649. It describes adventures in the Moon, and comments on the manners and customs of the lunar inhabitants. A hollow sky-rocket and an explosion; and the adventurer finds himself in the Moon. The story combines the romantic plausibility of Jules Verne with the gentle irony and ingenious wit of Dean Swift's "Gulliver."

Bergerac found the Lunarians had two kinds of speech. The upper classes used songs without words; and the populace, the speech of limb-motion. They lived on odors, for money used couplets and quatrains; their vegetables talked; (the soliloquy of a cabbage being one of the quaintest conceits of human thought). Their books are described as machine books; as follows:

* "No sooner was his back turned [he speaks of his Guide, whom he terms his "Spirit"] but I fell to consider attentively my Books and their Boxes, that's to say, their Covers, which seemed to me to be wonderfully Rich; the one was cut of a single Diamond, incomparably more resplendent than ours; the second looked like a prodigious great Pear, cloven in two. My Spirit had translated those Books into the Language of that World; but because I have none of their Print, I'll now explain to you the Fashion of those two Volumes:

As I opened the Box, I found within somewhat of Metal almost like to our Clocks, full of I know not what little Springs and imperceptible Engines. It was a Book, indeed, but a Strange and Wonderful Book, that had neither Leaves nor Letters. In fine, it was a Book made wholly for the Ears and not the Eyes. So that when any Body has a mind to read in it, he winds up the Machine

*Translation by A. Lovell, A.M., London, 1867; pp. 122-124. Doubleday & McClure 1899.

with a great many little Springs ; and he turns the Hand to the Chapter he desires to hear, and straight, as from the Mouth of Man, or a Musical Instrument, proceed all the distinct and different Sounds, which the Lunar Grandees make use of for expressing their Thoughts, instead of Language.

When I since reflected on this Miraculous Invention, I no longer wondered that the Young-Men of that Country were more knowing at Sixteen or Eighteen years Old, than the Gray-Beards of our Climate; for knowing how to Read as soon as speak, they are never without Lectures, in their Chambers, their Walks, the Town, or Traveling ; they may have in their Pockets, or at their Girdles, Thirty of these Books, where they need but wind up a Spring to hear a whole chapter, and so, more, if they have a mind to hear the Book quite through; living and dead, who entertain you with Living Voices. This Present employed me about an hour, and then hanging them to my Ears, like a pair of Pendants, I went to Walking."

This last paragraph certainly reminds one of the hearing-tube attachment, and conjures up the pictures of people one has seen listening, which pleased expression, to the Phonograph of to-day.

These are the earliest writings to be found that bear prophetically upon the subject. Compare now with another prophecy, written in 1878, after Edison's Phonograph had startled the world.

* "Then as to books, there seems some chance ere long the printer's if not the publisher's occupation will be gone, and the present unwieldy form of communication between an author and his readers be abolished. What would not one give to have the 'Christmas Carol' bottled up forever in Dickens' own voice, to be turned out at pleasure. Books, as Mr. Edison truly says, would often be listened to where they are not read ; and the

* From "Nature," Vol. XVIII, p. 117.

possibilities of the instrument in this direction may be learned from the fact that a book of 40,000 words might be recorded on four cylinders, eight inches long, with a diameter of five inches."

Coming down to recent times we find in Tom Hood's "Comic Annual" 1839, the following: "In this century of inventions, when a self-acting drawing paper has been discovered for copying visible subjects (referring to Daguerre's improvements in Photography) who knows but that some future discoverer may find some sort of writing paper to repeat what it hears"—a prophecy literally fulfilled by the indented tin-foil sheet of the early Phonograph.

Then again in 1844, Captain Matthew F. Maury (the famous hydrographer, the father of the United States Weather Bureau of to-day) wrote to a friend: * "What a pity it is that M. Daguerre, instead of Photography, had not invented a process of writing by merely speaking through a trumpet at a piece of paper. Instead of saying 'I wrote you a letter' the phrase would be 'I spoke you a ream.'" The prophesying becomes more exact as the time for the invention draws nearer.

Again, in 1855 (to quote from that happy essayist, George Parsons Lathrop) in an obscure book called † "Helionde, or Adventures in the Sun," there was printed another allusion to a supposed invention of the same sort, to this effect. "Aleutedon here informed me that authors had no occasion to employ manual labor in their publications, for they had only to repeat their ideas aloud, and the vibrations of the air differing accordingly to the words used, set in motion a very delicate machinery, which stamped indelibly the language expressed. Copies could afterward be taken in any number." It is interesting to note that even the terms used to express these predictions are closely allied to the true facts of the invention.

* See Memoirs, published in London in 1838.

† This anonymous writer evidently had for his source of inspiration Bergerac's "Histoire Comique," an extract from which has been quoted in full.—[Ed.]

Again, we find in 1875, that Jean Ingelow wrote a fairy tale in which there figures a strange instrument called an "Acousti-graph" which recorded music of all kinds, and reproduced it most weirdly and wonderfully. These instances may or may not be called prophecies, but they are wonderfully akin to a supernatural foreshadowing of the coming event, which is now to happen so soon.

CHAPTER III.—MORE MODERN HISTORY.

MEANWHILE in the world of Physical Science there had happened certain mechanical experiments and discoveries, which may be termed material prophecies, all of which pointed to the birth of the idea. There was Duhamel in the early 1700's with his lamp-black revolving cylinder, on which he traced sound curves. Then in 1747, the Rev. J. Creed proposed to make a machine to record extempore piano-forte or organ voluntaries. Following up the same idea, Hohlfeld of Berlin working with Euler, the mathematician, constructed in 1752 a crude music recorder called the Melograph. About the same time, another German mechanic, J. F. Unger, was also working on a similar instrument, and he finally proved priority of conception, dating his idea from 1745, even before Creed. Then one Pape of Paris, attracted considerable attention in 1824, with a music recorder; followed by Carreyre, in 1827, with his Melographic piano, in which the music as played was represented by certain signs impressed in a very thin plate of lead. In 1836, Eisenmanger of Paris, took out an English patent for an apparatus to record piano music, using a depressed stylus and carbonized paper. Then followed M. De Tressog of Paris in 1840, and Merzelo, an Italian in 1856, each with apparatus of a similar nature.*

* The dreams of these early inventors have become realized. The closing year of the 19th Century finds many automatic devices for recording piano music, not only perfected, but within the reach (at nominal prices) of the great music loving public.

All these machines, you will note, had for their object the recording only of music, and especially the piano or organ extemporizations. The growth of the perfected piano from the early clavier and clavichord, and the use of these instruments by the great German composers (Bach and Handl in the early 1700's, Haydn, Mozart and Beethoven, toward the close of the century, Spohr, Chopin, Mendelssohn, Meyerbeer and Liszt, in the 1800's), all this musical activity combined, brought with it the desire for an invention to record permanently the improvisations of these great artists and composers. So it is that Art fosters Science.

Following the keynote struck by Duhamel (the restless and fruitless searchings and strivings thus far recorded being but variations of the fundamental) the next note in the grand melody of Progress was sounded by Leon Scott, working with Konig in 1856, with his Phonautograph; recording the graphic traces of vibrations in sinuous scratches upon a smoked surface (useless, you will note particularly, for the purpose of reproduction of sounds).

Then came Fenby * with a patent, in 1863; closer and closer, but as yet not practical for an exact recording, and still less so for an exact reproduction of sound. Then came M. Charles Cros in April, 1877, (seven months before the date of the Edison patent, but several months after patent was filed). He deposited with the Academie des Sciences a sealed packet, which was opened at the December sitting of the Academy. It contained a general description of a device similar to the gramophone of to-day, the invention claimed by Berliner of telephone fame, in his patents of 1887-8.

In November, 1877, came the announcement of Mr. Edison that the phonograph was an ACTUALITY. The culminating

* In 1863, F. B. Fenby, of Worcester, patented "The Electro Magnetic Phonograph" (the same words which Edison employed some 14 years later). The scheme was complicated and no machine was ever made.—Grove's Dictionary of Music, Vol. IV, 767.

point of a generation of vague strivings had been reached. The fanciful foreshadowings of a hundred years had suddenly found fulfillment. The leading strings of centuries of thought converged on the tin-foil covered cylinder, which echoed back through Time, triumphantly to Cros, mockingly to Fenby and to Scott, kindly to Duhamel, Creed and Unger, pityingly to Faber, Vaucanson and Roger Bacon, respectfully to de Bergerac and the prophets, and gramercy to Amenophis III, the Memnon maker.

It is wonderful indeed, to contemplate the events of the century immediately preceding the birthday of the Phonograph. They indicate the strange trend of human invention; how it pointed in a given direction during a given time; how it needed but the presence of the great inventor to bring forth the solid truth, even as from an over-saturated solution there suddenly appears the shining crystal when the exact condition has finally arrived.

CHAPTER IV.—THE STORY OF THE INVENTION.

THE story of the invention is best told in Mr. Edison's own words. In an article on "The Perfected Phonograph" which he wrote for the North American Review in 1888, Mr. Edison calls attention to the well known effects of certain musical notes and chords upon sand, when loosely sprinkled on a sounding board; in response to the sound waves, the sand sifts itself into various geometric curves, differing according to pitch and intensity. He speaks also of the fine line of sand that is left high up on an ocean beach, as each breaker spends its force in its uttermost ripple, and then recedes. He draws the following parallel:

"Yet, well known though these phenomena are, they apparently never suggested until within a few years, that the sound waves set going by a human voice, might be so directed as to trace an impression upon some solid substance, with a nicety equal to that of the tide in recording its flow upon the sand beach. * * * * *

"My own discovery that this could be done came to me almost accidentally while I was busy with experiments, having a different object in view. I was engaged upon a machine intended to repeat Morse characters, which were recorded on paper by indentations that transferred their message to another circuit automatically, when passed under a tracing point connected with a circuit closing apparatus.

“In manipulating this paper, I found that when the indented paper was turned with great swiftness, it gave off a humming noise from the indentations, a musical rhythmic sound resembling that of human talk heard indistinctly.

“This led me to try fitting a diaphragm to the machine. I saw at once that the problem of registering human speech so that it could be repeated by mechanical means as often as might be desired, was solved.”—T. A. EDISON.

CHAPTER V.—THE FIRST PHONOGRAPH.

(From The N. Y. SUN of March 1st, 1899.)

THE man who made the first phonograph was buried at Schenectady on February 25, 1899. He was one of the little band of men who worked with Thomas A. Edison at Menlo Park, and through whose skill and faithful assistance were developed many of the inventions which gave to Edison the name of "The Wizard." It was in those days that Edison used to become absorbed in the development of an idea, work at it without rest or sleep for two or three days and nights and keep all those about him busy at the same time. He would call in an organ grinder from the streets to keep his men awake, or resort to some other such device, and when the strain was finally over, charter a boat and take all hands down the bay on a fishing excursion. Among the most tireless of the men about "The Wizard" at that time was John Kruesi, the man who made the first phonograph.* The idea came to Mr. Edison as an inspiration a few days before, while he was experimenting with a telephone disc. The disc was not enclosed and there was a sharp, pointed pin on the back of it.

As Mr. Edison spoke against the face of the disc its vibrations drove the pin into his finger.

* For many years Mr. Kruesi had been identified with the General Electric Co. at their Schenectady Works, filling a position of great importance.—[Ed.]

“ If the disc has power enough to prick my finger,” thought ‘The Wizard’, “ it has power enough to make a record which can be reproduced.”

A few days later he called Kruesi to him, and putting into his hands a rough sketch of the Phonograph, explained what the thing was to do, and told him to make it. It was a roll machine, the roll covered with tin foil to take the record. Kruesi made the machine and brought it to Mr. Edison. Edison set it going and spoke into it :

“ Mary had a little lamb,
It's fleece was white as snow ;
And everywhere that Mary went,
The lamb was sure to go.”

Then he started it to repeat his words, expecting at the best but a hoarse murmur in answer. He was almost awed when he heard his words actually repeated in clear tones by the little machine. That machine is now in the Patent Museum at South Kensington, London, England.



EDISON WORKING ON THE PHONOGRAPH.

CHAPTER VI.

PICTORIAL AND COMMERCIAL HISTORY.

IN the preceding chapters there have been traced, first the growth of the Idea; next, the events leading up to the Invention, and finally, the Invention. The growth of the Invention itself, from the crude tin foil covered roll and rough apparatus of

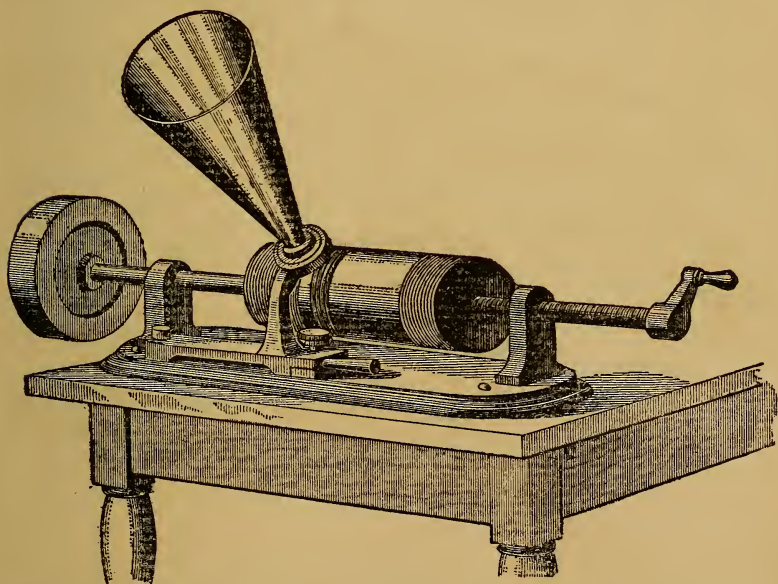

THE PHONOGRAPH OF 1877—showing recording stylus indenting the tin foil on a 5 inch cylinder.

1877, to the lead soap record of to-day, (popularly termed the "wax" cylinder) and the delicate and positive mechanism which distinguishes the modern Phonograph can be told best by reproducing the early prints. These pictures, though lacking in art, tell the story of progress so plainly that, few explanatory words are needful.

Then followed a period of nearly ten years during which the Phonograph remained quiescent, the reason for which is given in the following quotation taken from Mr. Edison's article in the North American Review, June 1888: "Ten years ago I

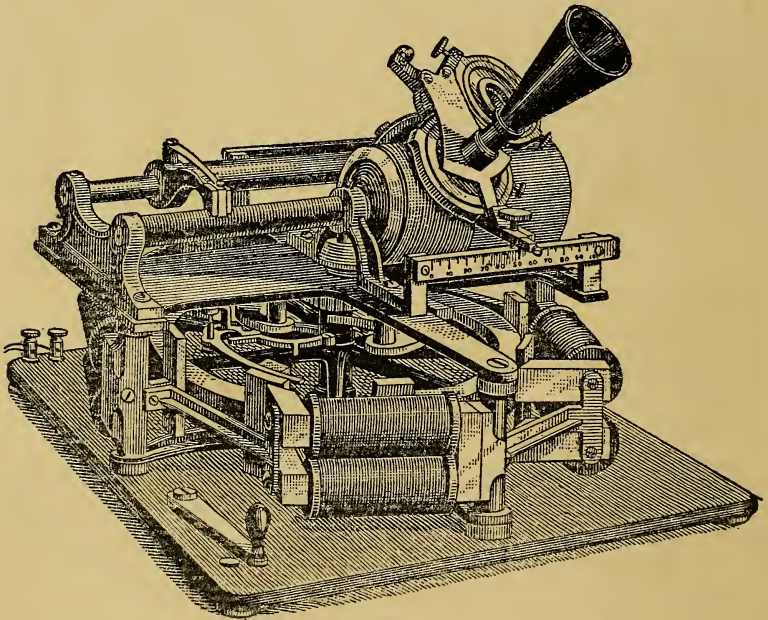

THE PHONOGRAPH OF 1887—showing the use of the wax cylinder, electric motor works and recording and reproducing diaphragms arranged on a swivel, for instant interchange. This is the "Spectacle" model, so-called from the resemblance of the Diaphragms to a pair of eye-glasses.

contributed to the North American Review a paper on 'The Phonograph and its Future,' in which I sketched the solution of certain problems accomplished by my invention and predicted some of the uses to which it would be put. Other weighty matters engaged much of my time and attention after that article was published ; but the future of which I then spoke has now arrived, and the predictions which I made at that time are now verified."

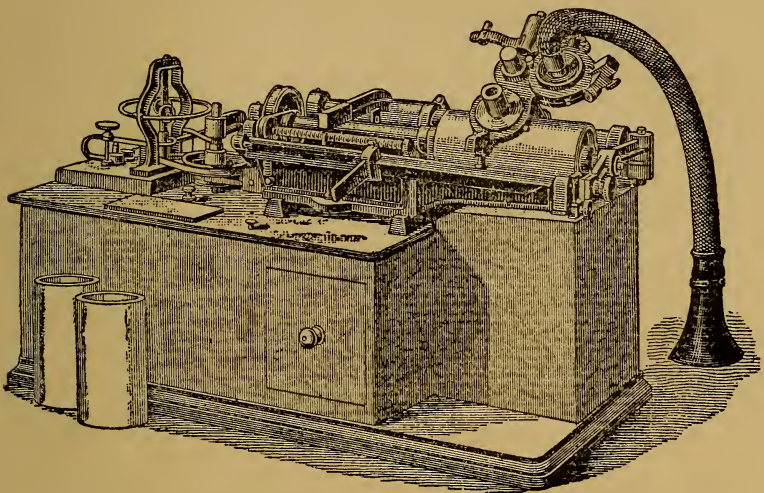

The improved "Spectacle Model" dating 1889.

About this time The North American Phonograph Co. started to manufacture and market the Phonograph, offering it solely as an office convenience; that is to say, as an amanuensis, in place of a stenographer. On account of its high price, no thought was taken of the enormous latent possibilities of the Phonograph as a fun maker or home entertainer. It may be of interest to quote from a catalogue of 1893, and also to reproduce the illustrations of the different types of machines sold, together with prices.

THE EDISON PHONOGRAPH.

As the ideal amanuensis for office use.

In recommending the use of the Phonograph in business offices, THE NORTH AMERICAN PHONOGRAPH COMPANY feel that they are advising the introduction of a machine which will do *all* that is claimed for it, and which will fill a position that was as vacant, before the Phonograph was used, as the one now filled by the typewriter was years ago.

THE PHONOGRAPH WILL SAVE YOUR TIME AND YOUR MONEY.

You can talk faster than to a stenographer and your typewriter can transcribe more quickly than from stenographic notes, not being obliged to look at the notes and find the place.

Your typewriter can begin to transcribe the first of your correspondence at the same time that you are dictating the remainder, and the work is completed sooner than if a stenographer had to wait until the dictation was finished before beginning to transcribe.

THE PHONOGRAPH ADDS TO YOUR CONVENIENCE.

You can dictate while your typewriter is absent or doing other work. With more than one Phonograph in the office different men can dictate their letters at the same time, and one typewriter can transcribe for all.

MOTOR BATTERIES, ETC.

The Phonograph is built in four different classes, according to whether it is to be run by an Electric Motor and Battery ; an Electric Motor attached to an Electric Light Current ; a Water Motor ; or a Foot Treadle.

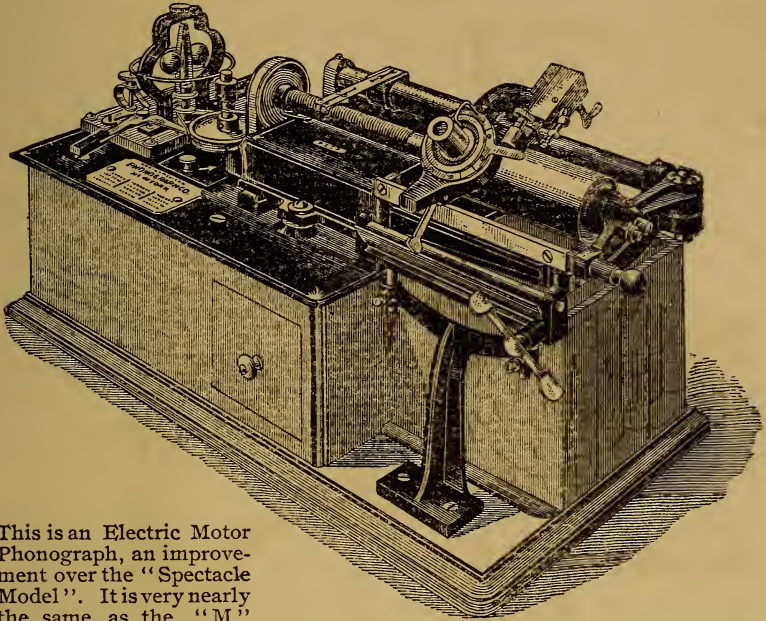

This is an Electric Motor Phonograph, an improvement over the "Spectacle Model". It is very nearly the same as the "M"

Electric Phonograph of to-day, except for a few unimportant details. Equipped with a battery, tubes, blanks and sundries, it sold for \$190. The same Phonograph wound for the electric light circuit sold for \$170.

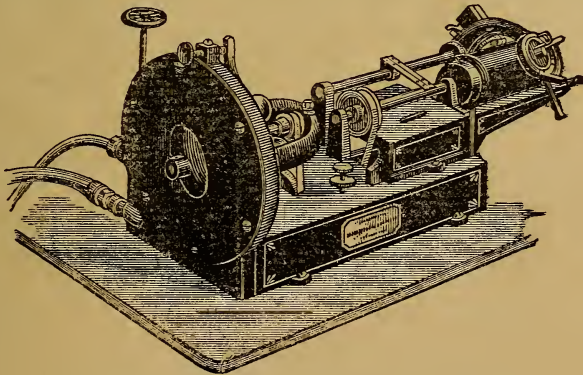

The Water Motor Phonograph sold for \$150.00.

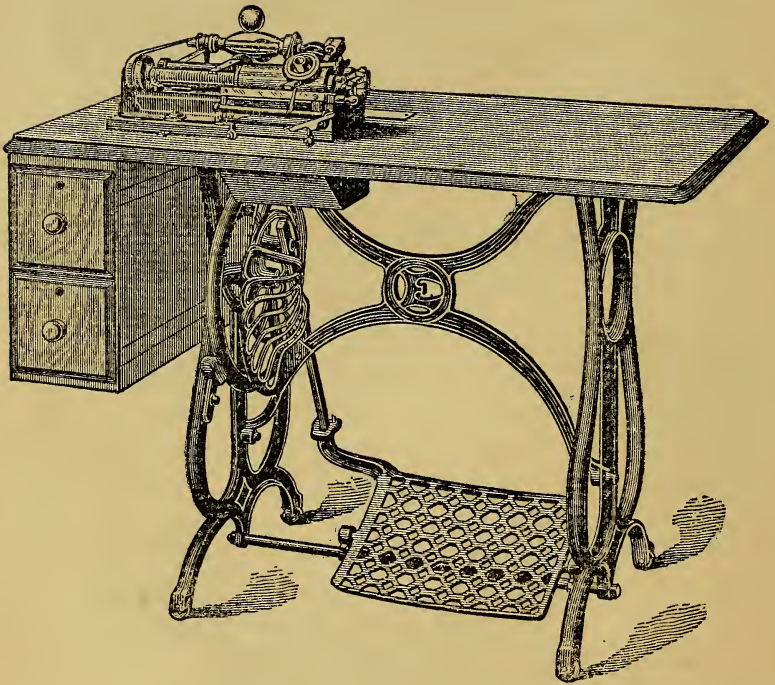

This Phonograph, equipped with foot power treadle, sold for \$140.00.

In 1895, The National Phonograph Co. took up the sale of Phonographs and discarded the Treadle and Water Motor types. Under its management the Electric Motor appeared in the following form :

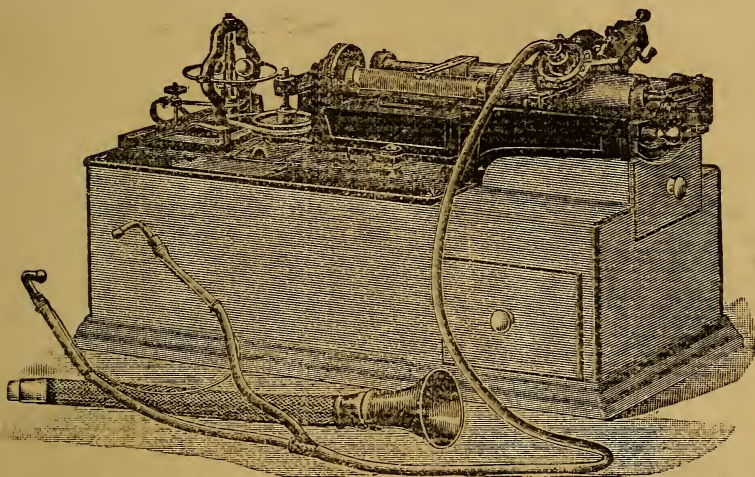

The Edison "M" Electric Phonograph.

and a new type was added which was called The Edison Spring Motor Phonograph.

The Phonograph was now growing in popularity as a means of amusement for the general public ; and in response to a wide demand for a cheaper instrument, another style was added, also of the clock work type, called the Edison Home Phonograph.

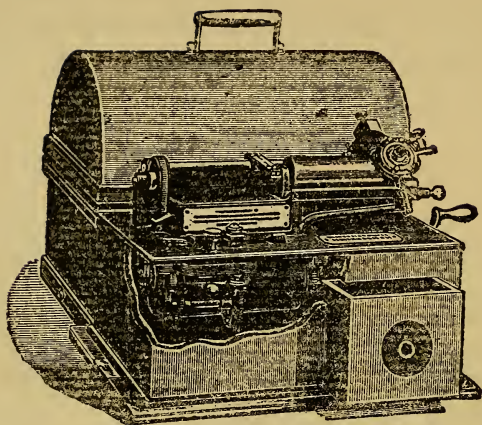

The Edison Spring Motor Phonograph.

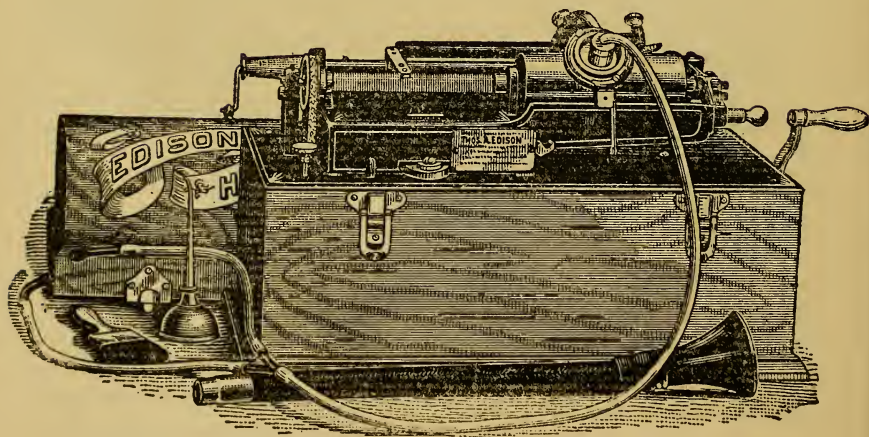

The Edison Home Phonograph.

In 1897, to keep pace with the growing popular demand, a still cheaper Phonograph, called "The Standard" was put on the market.

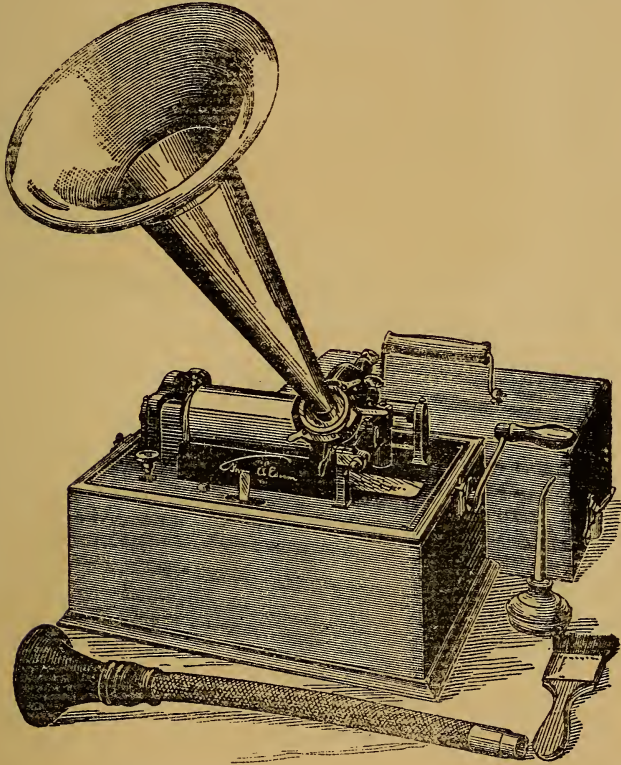

The Edison Standard Phonograph.

Early in 1899, a still more moderate priced machine, known as "The Gem," was placed before the public. This machine

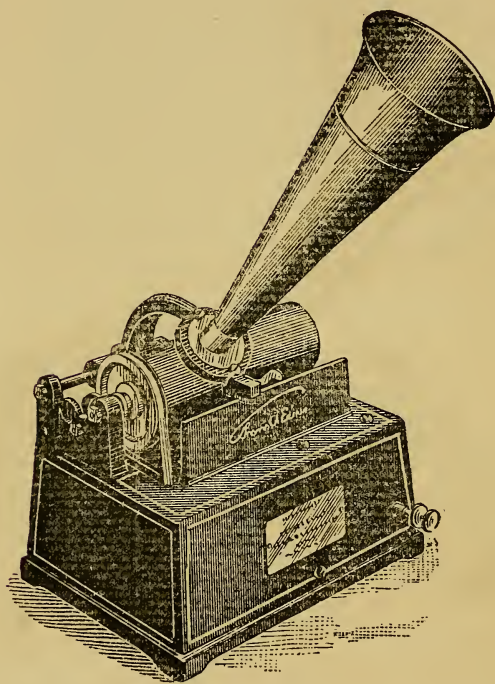

The Edison Gem Phonograph.

came as a revelation to the Phonograph world ; as an example of what could be accomplished in small compass and for a small price.

Following the Gem, came the announcement that Mr. Edison had perfected the Phonograph, and had produced the "Concert," a machine playing a record 5 inches in diameter (a return to the

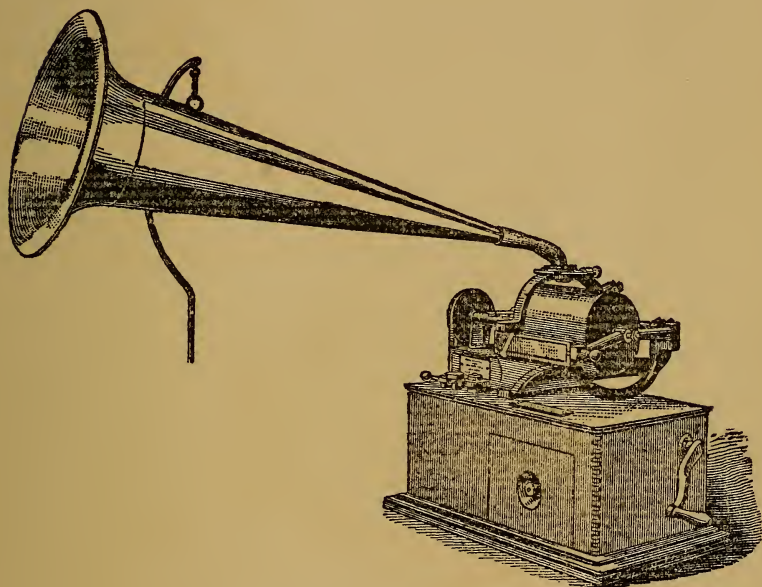

The Edison Concert Phonograph.

size of the original tin foil covered record). So perfect is its work, that seeing it dispels an illusion.

After hearing it there can be but one conclusion—Thomas A. Edison is the Alpha and Omega of the Phonograph.

PART SECOND

HOW TO USE IT

INTRODUCTION.

NOT very many years ago a Phonograph cost five hundred dollars. To-day the best Phonograph costs only one hundred dollars ; and smaller instruments can be bought all the way down to seven dollars and fifty cents. The reasons for this are two-fold : improved method of manufacture and tremendously increased output.

Phonographs differ from all other talking machines in that they are offered to the public complete in every respect. With the exception of the Gem, they all make records, reproduce records and shave off records for use a second time.

Phonographs are made with the accuracy of a scientific instrument. They run smooth, they run true and they run in perfect time. They are made honestly. They are made to reflect credit and to uphold the fame of the name that is behind them. Mr. Edison's signature is on every Phonograph ; without it no other is genuine.

Any one who knows about talking machines can tell the difference at a glance, or by hearing the results. Any one who does NOT know, can also tell. Look for the signature.

No amusement of modern times equals the Phonograph. Every pleasure that sound can give is condensed on its cylinders, and the privilege of "boxing" your own and your friends' voices for future use is a never failing source of amusement.

Its variety is inexhaustible, for as long as human genius keeps on producing new music, new recitations, new instruments, the Phonograph goes on making permanent the otherwise fleeting pleasure.

The charm of the enjoyment depends on the clearness and accuracy of the reproduction and for this reason the Phonograph gives greater satisfaction than any other device sold for this purpose.

TWO TYPES AND EIGHT STYLES.

Six styles are made that use the same records, the small $2\frac{1}{4}$ inch size. The other two styles use the large 5 inch records.

SPRING MOTOR TYPES.

The Edison Concert (plays the 5 inch Edison Concert Records).

The Edison Spring Motor.

The Edison Home.

The Edison Standard.

The Edison Gem.

ELECTRIC TYPES.

The Edison "M" Electric.

The Edison "E" Electric.

The Edison "M" Concert (plays the 5 inch Edison Concert Records).

With the exception of the GEM they all do the same things, but in different ways. They will record and reproduce human speech and other forms of articulate sound. They will record music and reproduce it afterwards. They will repeat what has been sung, spoken or played by others to the machine. They will shave off or prepare cylinders that once have had speeches or songs recorded on them, so that every cylinder can be used again and again for new records, if desired.

The Phonograph is the best of such instruments, because it does these things simply and perfectly. It will sing for you, it will play for you, it will repeat to you the music of famous bands and orchestras, the sweet voices of famous singers, and the precious voices of family and friends, even though they be dead. It is a remembrance reduced to the visible presence. It preserves what otherwise would have perished, and it entertains and amuses people of all ages and stations beyond any device, mechanical or otherwise, ever invented.

The world owes this wonderful invention, and its present advanced development, to the great genius of THOMAS A. EDISON.

DESCRIPTION OF TYPES AND STYLES.

The two types of Phonographs are the Spring Motor and the Electric. The following briefly describes the eight different styles:

CONCERT The Edison **CONCERT** represents the perfection of the Phonograph. The motor is actuated by powerful triple springs; will play from six to eight of the large 5 inch records with one winding. For volume of sound, true tone quality and distinct articulation this Phonograph stands alone.

SPRING MOTOR The Edison **SPRING MOTOR** is a high grade instrument. The motive power of this machine is a powerful spring motor movement contained in the machine itself, and wound with a crank. It plays fourteen records with a single winding.

HOME The Edison **HOME** is also a spring motor machine made for popular home use. It works admirably, having the same speaking and musical qualities, and using the same devices to accomplish those results. The spring

motor is well made and differs from the larger motors only in not running so long with a single winding.

The Edison STANDARD is a standard machine in STANDARD every respect. It is built on the same general lines as the Home, with the exception of a different arrangement of the feed. The motor runs from two to three records with one winding. It is durable, handsome and attractive in appearance.

The Edison GEM is the cheapest genuine Phono- GEM graph on the market. It is compact, neat and substantial. Reproduces only, but with wonderful clearness. Plays two records with one winding.

The Edison "M" ELECTRIC Phonograph is actuated ELECTRIC by an electric motor, which forms part of the CLASS M. machine. The power for running it is supplied by a battery, which it not a part of the machine, but must be purchased as an extra. The machine is perfect in all details, and accurate and brilliant in reproduction.

The Edison "E" ELECTRIC Phonograph (for CLASS E. electric light current), is furnished with an electric motor wound for the 110 to 120 volt direct current. The outfit is similar to the "M" Electric in every respect except the motor.

The Edison "M" CONCERT Phonograph differs from CLASS M. the Spring Motor Concert in the motive power. CONCERT Power is supplied from a battery, as in the "M" electric. Combines the perfection of the Concert with the convenience of the "M" electric.

In the descriptions of the Phonographs which appear in the following pages, the GEM stands first in order. Its phenomenal sales record in the first few months since it was brought out

proves its popularity and hence it leads in the prominence given to the written instructions as to its use.

The STANDARD and the HOME come next; taking these positions from a comparison of the number in actual use.

The Spring Motor follows, although it was the *first* machine of its type; with its clockwork mechanism.

Then the CONCERT; which is closely allied in general form to the SPRING MOTOR, differing only in the Phonograph body, and in such changes that are needful to operate the 5 inch instead of the 2¼ inch cylinder.

Finally the Electric Phonographs are treated; followed by chapters of general information as to the use and care of the various attachments and accessories, of which the Phonograph has a large and ever increasing number.

CHAPTER I.

THE EDISON GEM PHONOGRAPH.

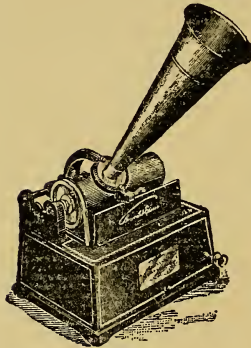

THE Edison GEM is the cheapest genuine Phonograph on the market. It is the best cheap talking machine. Its construction is solid and substantial. Its works are enclosed in enamelled iron base, tastefully decorated, and are well made. Good gears, stiff spring, will run two records with one winding. All studs and bearings are made of best steel. Its mechanism is the acme of simplicity. Weighs $7\frac{1}{2}$ pounds. Size of base $7\frac{3}{4} \times 5\frac{3}{4}$ inches. It is equipped with a 10-inch japanned horn. Reproduces only, but reproduces with wonderful loudness and clearness. Plays the $2\frac{1}{4}$ inch record.

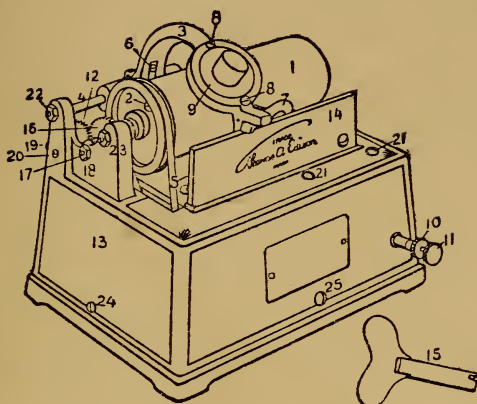

THE EDISON GEM PHONOGRAPH.

INDEX OF PARTS.

- | | |
|--|--------------------------------------|
| 1. Mandrel (to hold Wax Cylinder),
assembled with Cylinder Shaft. | 12. Feed Screw Gear. |
| 2. Cylinder Pulley (assembled with
gear). | 13. Body. |
| 3. Speaker Arm. | 14. Straight Edge. |
| 4. Back Rod. | 15. Winding Key. |
| 5. Drive Belt. | 16. Intermediate Gear. |
| 6. Feed Nut Spring Screw. | 17. Intermediate Gear Stud. |
| 7. Speaker Arm Lift Lever. | 18. " " " Nut. |
| 8. " Clamp Screws. | 19. Cylinder Shaft Center Set Screw. |
| 9. Tube Plate, under which is the
Speaker. | 20. Feed Screw Center. |
| 10. Speed Adjusting Screw. | 21. Frame Holding Screws. |
| 11. Starting Knob. | 22. Back Rod Nut |
| | 23. Cylinder Rod Nut. |
| | 24. Drip Pan Screw. |
| | 25. Gov. Brake Angle-piece Screw. |

INSTRUCTIONS FOR OPERATING THE GEM PHONOGRAPH.

Before winding or starting, see that all working parts are free and clear from dirt and packing, particularly the gear wheels. See that all set screws are tight, as sometimes these screws work loose from the jars or knocks received in transportation. To get at the interior mechanism, remove the drip pan by taking out the round head screws (24) in each end of the iron base (13).

In moving the speaker arm (3) back and forth, *always use the lift lever* (7), so that the arm slides on the straight edge (14). Do not lift the entire arm, as the pin on back part of speaker arm will strike the feed screw and damage the thread.

The Gem Phonograph, like every other good mechanism, should be *kept clean*. This is absolutely essential as to the gearing. Any foreign substance in the gear teeth or bearings, (such as grit or packing or gummy oil), affects the regularity of the movement, and consequently the speed regulation. If the machine does not regulate perfectly, it shows in the varying pitch of the record when played.

Apply oil sparingly but thoroughly to the following parts: Back rod (4). Feed screw (not shown in cut). Feed screw centers (20). A *very* little on the straight edge (14) rubbed on with the finger. All motor shafts at their bearings. All gears, especially the fine-toothed gear which engages the governor pinion. Arbor on which main spring turns. Idler pulley, occasionally, where tension spring holds it. Governor disc, occasionally. No oil should be permitted to get on the belt (5), and oil must not be smeared on the machine, as it will catch dust and make trouble. When the oil on the gear teeth gets black and dirty, wash it off with benzine before putting on new oil, which apply sparingly. Use best Phonograph oil, to avoid gumming. Above all, keep the machine clean. No mechanism will work perfectly unless free from grit.

As a precautionary measure, it is well to look to the belt (5)

and speaker arm (3) before starting the machine. All machines are completely adjusted before shipment from the factory. They will sometimes, though not often, become disarranged in transit. The tension of the belt should be moderate. The mandrel (1) should work freely. A simple test is to throw off the belt (5) and spin it gently with the fingers. The speaker arm (3) should also slide freely on the back rod (4).

To Adjust Cylinder To adjust the wax cylinder, raise the lift lever (7) and slide it to the center of the straight edge (14), as shown in cut. DON'T LIFT ENTIRE ARM. Slip the wax cylinder, beveled end foremost, upon the tapering mandrel, handling it very carefully. Push it on the mandrel until it holds firmly; not too tight, or it may crack the record, nor yet too loose. If the latter happens, the cylinder revolves on the mandrel, making the record repeat.

The wax cylinder, which is somewhat brittle, should be handled gently at first, until the operator becomes practised. See *Chapter 13, Part II., BLANKS AND RECORDS.* Do not leave the cylinder upon the mandrel (1) of the Phonograph for any length of time when the machine is not in use.

To Start and Stop To start the machine, push the starting knob (11). To stop, pull out this knob. To regulate the speed, turn thumb-screw (10). To increase speed, screw thumb-screw in, and to decrease it, unscrew same. Observe this carefully when reproducing music, as a different speed from that at which the music was recorded will reproduce an entirely different pitch. The standard speed at which musical records are taken is about 125 revolutions per minute.

To Reproduce Raise lift lever (7) to its highest point. Slip the wax cylinder, beveled end foremost, upon the tapering mandrel (1), and press it firmly, but not too forcibly, into place. Place the horn on the speaker plate tube,

slide speaker arm (3) to point where record appears to begin, and drop lift lever gently (7), after having first pushed in starting the knob (11).

Although the reproducer ball usually adjusts itself to the track or groove made by the stylus, it sometimes occurs that clear reproduction is not at first obtained. To obviate this, jar the machine gently; which usually throws the reproducer ball into track, or raise lift lever and drop it again gently until the reproduction sounds clearer.

CHAPTER II.

THE EDISON STANDARD PHONOGRAPH.

THE STANDARD is the ideal talking machine. It is made with the same careful precision that characterizes all Phonographs, and is complete in every respect. Made of iron, steel and brass, nicked gears and mandrel. Black enamel and gold finish. Encased in a handsome oak dust-proof carrying case. Actuated by a spring motor that runs two to three records with a single winding. Crank handle does not revolve while the machine is running. Can be wound while in motion without interfering with reproduction.

Light, durable and efficient. Absolutely noiseless. Regulation perfect. Can be operated by a child, so simple is its mechanism. Weighs 17 lbs. Size, 9 in. x 12 in. x 9½ inches high. Will record, will reproduce, will shave off. Fitted with instantaneous speaker clamps for instant interchange of speakers.

Two Speakers are included, free of charge with every Edison STANDARD Phonograph: The Edison Automatic Reproducer and the Edison Recorder; also a sapphire shaving knife, a two-way hearing tube a 14-inch polished brass horn, a camel's hair chip brush, an oil can, a winding crank and an oak carrying case.

These parts are essential to a perfectly equipped and complete talking machine outfit. The STANDARD is shipped only complete as above. The only change made is to substitute a speaking tube for the 14-inch polished brass horn, if so desired.

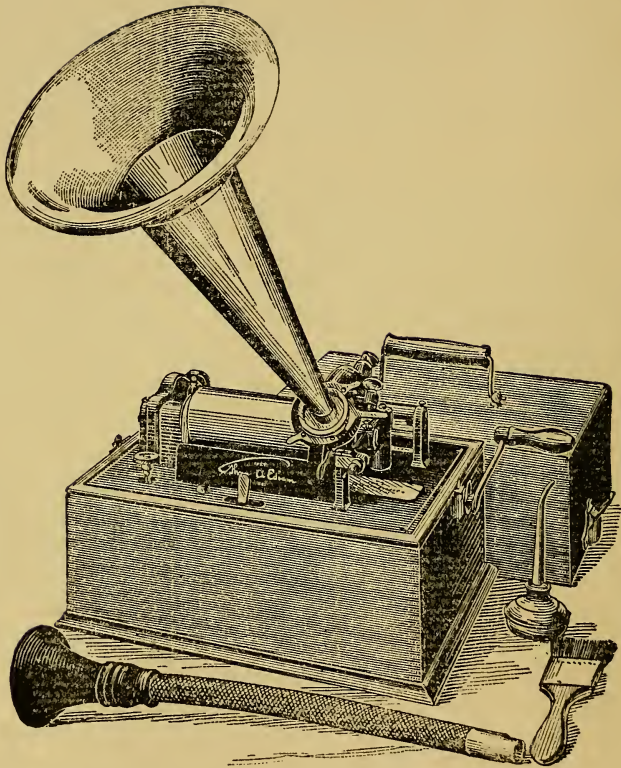

The Edison Standard Phonograph.

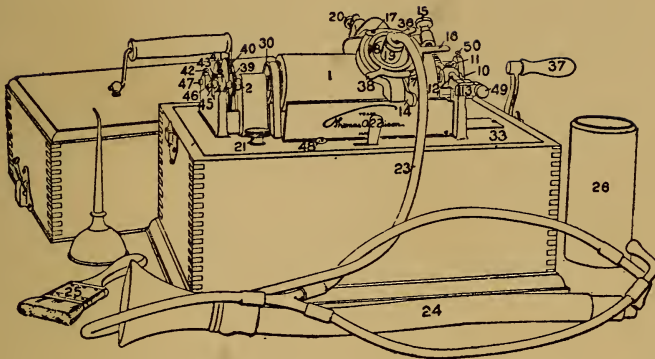

THE EDISON STANDARD PHONOGRAPH

INDEX OF PARTS.

- | | |
|--|---------------------------------------|
| 1. Brass Mandrel to hold wax cylinder (assembled with Cylinder Shaft). | 25. Chip Brush |
| 2. Cylinder Shaft, (assembled with Brass Mandrel). | 26. Wax Cylinder, or Blank. |
| 3. Feed Spring. | 27. Swing-arm Spring Washer. |
| 4. Feed Nut. | 28. Swing-arm Spring Washer Screw |
| 5. Feed Nut Screw. | 29. Chip Chute Thumb Screw. |
| 6. Back Rod. | 30. Cylinder Shaft Pulley. |
| 7. Drive Belt. | 31. Feed Screw Cover. |
| 8. Feed Nut Spring Screw. | 32. Feed Screw Cover Screw. |
| 9. Speaker Arm. | 33. Top Plate. |
| 10. Swinging-arm Center. | 43. Speaker Arm Lift Screw. |
| 11. Swinging-arm Center Set Screw. | 35. Straight Edge Roller. |
| 12. Swinging Arm. | 36. Straight Edge Roller Screw. |
| 13. Locking Spring. | 37. Wincing Crank. |
| 14. Speaker Arm Lift Lever. | 38. Speaker Clamps. |
| 15. Speaker Adjusting Screw. | 39. Cylinder Shaft Gear. |
| 16. Speaker Lever. | 40. Intermediate Gear. |
| 17. Speaker Clamp Screw. | 41. Feed Screw Gear. |
| 18. Speaker. | 42. Feed Screw Center Set Screw. |
| 19. Plate Tube. | 43. Intermediate Gear Stud Set Screw. |
| 20. Knife Bar Adjusting Screw. | 44. Cylinder Shaft Center Set Screw. |
| 21. Governor Adjusting Screw. | 45. Cylinder Shaft Center. |
| 22. Starting Lever. | 46. Intermediate Gear Stud. |
| 23. Hearing Tube. | 47. Feed Screw Center. |
| 24. Speaking Tube. | 48. Frame Holding Screw. |
| | 49. Locking Spring Knob. |
| | 50. Back Rod Set Screw. |

The Phonograph, like every other good mechanism, should be cleaned and free from dust. Instructions as to oiling will be found later in these directions.

See that the knife adjusting screw (20) is screwed entirely back, or until the chip box rests against the casting of the speaker arm, as it always should do except when shaving. This screw controls the shaving knife, and draws it away or forces its cutting edge against the wax cylinder.

As a precautionary measure, it is well to look to the belt, the shaft (2), and the speaker arm, before starting the machine. All machines are completely adjusted before shipment from the factory. They will sometimes, though not often, become disarranged in transit. The tension of the belt should be moderate.

Before winding or starting the machine, see that all working parts are free, particularly that there is no dirt or packing in the gear wheels, and that all set screws are tight. Sometimes these screws work loose from the shock of travel.

The cylinder shaft (2) turns on centers (10 and 45), between which it should run easily. If centers are too tight they will bind the shaft, while if too loose, the end shake will destroy the accuracy of the reproduction. There should be no end-shake here. A simple test is to throw off the belt with the hand, and see if the shaft will spin freely. The cylinder shaft centers are regulated by set screws (11 and 24), as shown in the drawing. The speaker arm or carriage of the machine should work free on the back rod.

All bearings should be oiled, as mentioned before, and to obtain the best results from the motor the gears must be kept clean, particularly the fine-toothed gear which engages the governor pinion. The governor disc (the flat metal plate against which the horse shoe rocker works) must be oiled occasionally. If necessary to adjust the governor, see to it that there is a slight play between centers. If too tight there, regulation is impaired and efficiency is diminished.

Under no circumstances should the governor disc, described above, touch the adjacent gear.

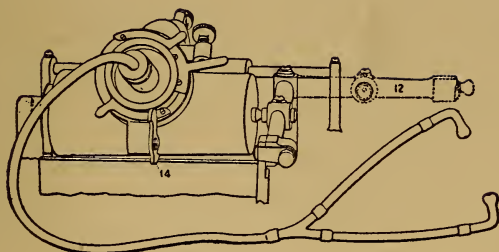

NOTE:—For numbers not shown on this cut refer to cut of complete machine on Page 53.

To Put the Wax Cylinder on or to Remove It Open swing arm (12), raise lift lever (14), and slip the wax cylinder (26), beveled end foremost, upon tapering brass mandrel (1).

Handling the Cylinder The wax cylinder, which is somewhat brittle, should be handled gently at first, until the operator becomes practised. *See Chapter 13, Part II., BLANKS AND RECORDS.*

Do not leave the cylinder upon the brass mandrel (1) of the Phonograph for any length of time when the machine is not in use.

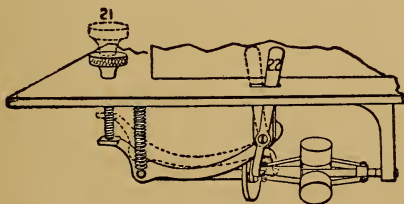

To Start or Stop To start or stop, throw switch lever (22); to the right to stop and to the left to start.

*To Regulate
the Speed*

The speed of the machine in revolutions of the main shaft per minute is regulated by the speed adjusting screw (21). To increase speed screw the nut down, and to decrease it unscrew this nut. Observe this carefully when reproducing music, as a different speed from that at which the music was recorded will produce an entirely different pitch. The standard speed at which musical records are taken is about 125 revolutions per minute; talking records, about 80 per minute.

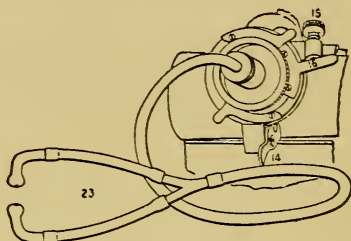

NOTE:—For numbers not shown on this cut, refer to cut of complete machine on page 53.

*To Repro-
duce*

Raise lift lever (14) to its highest point. Push speaker lever (16) to its highest point, against adjusting screw (15). Open swing arm (12) wide. Slip the wax cylinder (26), beveled end foremost, upon the tapering brass mandrel (1), and press it firmly, but not forcibly, into place. Close swing arm. Now place hearing tube (23), or horn, on the speaker plate tube (19). Slide speaker arm to point where record appears to begin, and drop lift lever (14), after having first thrown lever (22) to the left.

With the Automatic Speaker the following adjustment is unnecessary, as the reproducer ball adjusts itself to the track or groove made by the stylus. With the Standard Speaker (a combination speaker equipped with both recording and reproducing

sapphires), it sometimes occurs that clear reproduction is not at first obtained. To obviate this, unscrew the adjusting screw (15) until its point disappears in the lug, and while listening press the speaker lever (16) upward with the thumb of the right hand, and with the first and second fingers of the same hand turn the adjusting screw (15) slowly down until you can hear the record distinctly. This adjustment will bring the reproducer ball into the groove of the record.

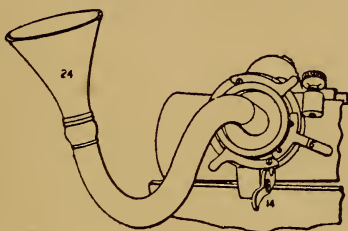

The machine is at rest. Open speaker clamps (38) and insert recorder with its speaker lever (16) pressed up against lug. Press up lift lever (14). Open swing arm (12) wide.

Slip the wax cylinder (26), beveled end foremost, upon the tapering brass mandrel (1), and press it firmly, but not too forcibly into place. Close the swing arm.

Raise the speaker arm from the straight edge upon which it rests in front, and slide to the left until directly over the beveled end of the cylinder, or the point at which you wish the record to commence. Again lower it to straight edge. Everything is now ready to record.

Start the machine by pushing the starting lever (22) to the left. The machine is now in motion. Place speaking tube or horn upon the plate tube (19) of the speaker, lower lift lever (14)

as far as possible and commence recording. *Further instructions are given in Chapter 15, Part II., DICTATING; and Chapter 5, Part III., RECORD MAKING.*

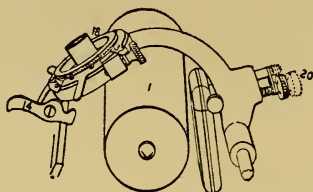

Shaving Cylinders

Every Phonograph except the Gem is equipped with a simple device for shaving off or smoothing blank cylinders, which preparation is necessary before a blank can be used for recording. Here are the instructions for operating the turning rest. Machine is at rest. Wax cylinder firmly set upon mandrel. Hearing tube or horn removed. Fasten back the speaker weight by passing rubber band around lower end of weight and over the speaker arm, or what is better still, remove speaker (18).

Lower the speaker arm about over the center of the cylinder by dropping lift lever (14). Hold the end of the arm down firmly with the thumb and forefinger of the left hand, while with the same fingers of the right, screw down the button (20) which controls the knife bar. This will bring the sapphire shaving knife to the surface of the wax. As the depth of the cut to be taken is very slight indeed, the knife must be set very gently into the wax, as shallowly as possible. The machine is still at rest, with lift lever (14) down. Now raise speaker arm, slide it back to the extreme left, and start the Phonograph. When the shaving of a cylinder is completed, see that the knife bar is screwed back away from the cylinder, or it will cut the next record that is put

on the machine. This is managed by manipulating the button (20). *Further instructions are given in Chapter 14, Part II., SHAVING.*

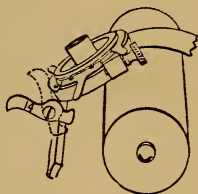

To Stop To stop recording, reproducing or shaving while the machine is running, raise the lift lever (14).

Oiling Apply oil sparingly but thoroughly to the following parts: back-rod, feed screw, cylinder shaft centers (10 and 45) feed screw center (47), roller on the straight edge, all motor shafts at their bearings, all gears, arbor on which main spring turns; idler pulley, occasionally where tension spring holds it; governor disc, occasionally, winding shaft, if necessary. No oil should be permitted to get on the belt, and oil must not be smeared on the machine, as it will catch dust and make trouble. When the oil on the gear teeth gets black and dirty, wash it off with benzine before putting on new oil, which apply sparingly. Use best Phonograph oil to avoid gumming. Above all, keep the machine clean. No mechanism will work perfectly unless free from grit.

CHAPTER III.

THE EDISON HOME PHONOGRAPH.

A COMPLETE talking and musical machine that does the same work as the high-priced instruments, and superior to all of the cheap machines for music. It is simple in construction, easy to operate and costless to maintain. Equipped with a spring motor that runs six records with a single winding. It is made of steel, iron and brass throughout. No soft metal or composition. Finished in black enamel and gold. Incased in oak box with illuminated oak cover, forming complete carrying case. Size, 8 in. x 16½ in. x 12 in. high. It weighs 25 lbs. Will record, will reproduce, will shave off. Fitted with instantaneous speaker clamps for instant interchange of speakers.

Two speakers are included, free of charge, with every Edison HOME Phonograph; the Edison Automatic Reproducer and the Edison Recorder; also a sapphire shaving knife, an oak body box, oak cover, a 14-inch polished brass horn, a two-way hearing tube, a winding crank, an oil can and a camel's hair chip brush.

These parts are essential to a perfectly equipped and complete talking machine. The HOME is shipped only complete as above. The only change made is to substitute a speaking tube for the 14-inch polished brass horn, if so desired.

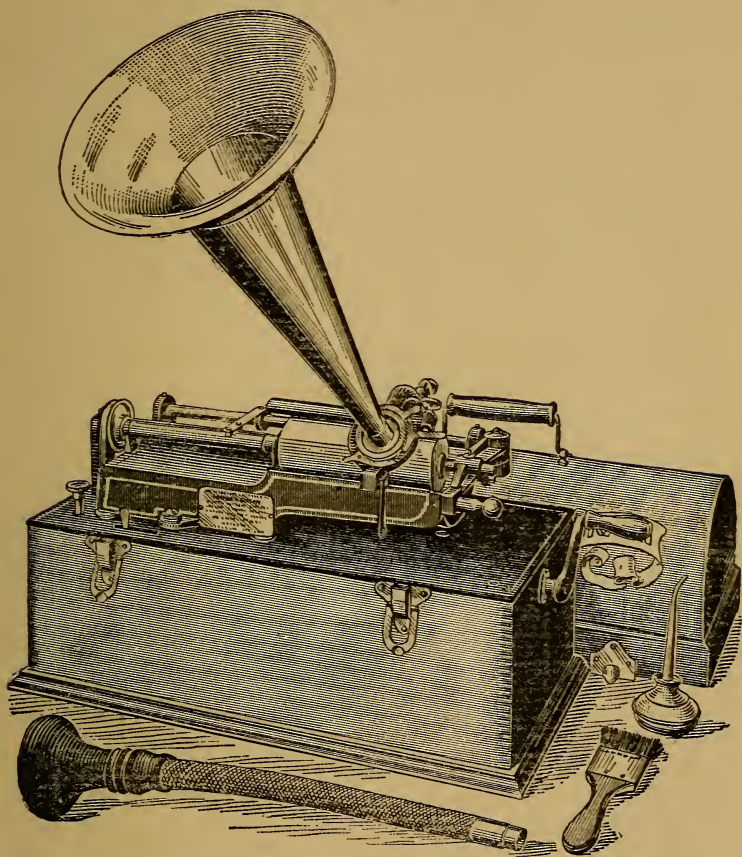

The Edison Home Phonograph.

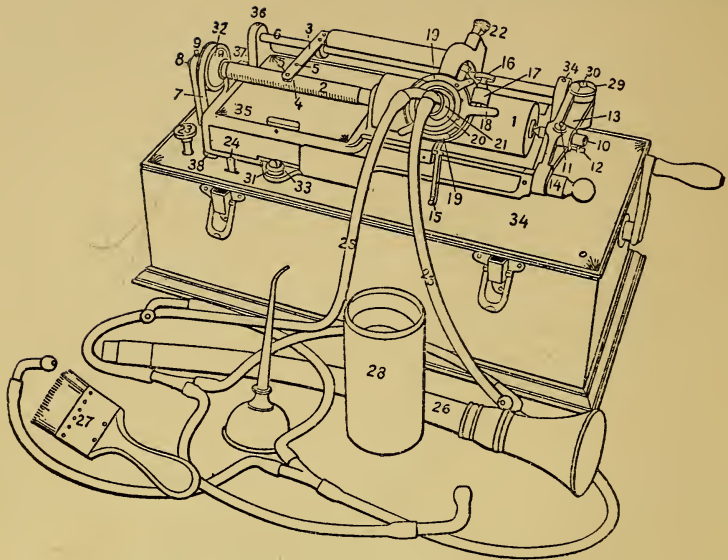

THE EDISON HOME PHONOGRAPH

INDEX OF PARTS.

- | | |
|---|---|
| 1. Brass Mandrel to hold wax cylinder. (Assembled with Main Shaft). | 19. Speaker Clamps. |
| 2. Main Shaft. (Assembled with Brass Mandrel). | 20. Speaker. |
| 3. Feed Spring. | 21. Tube Plate. |
| 4. Feed Nut. | 22. Knife Adjusting Screw. |
| 5. Feed Nut Screws. | 23. Speed Adjusting Screw. |
| 6. Back Rod. | 24. Start-and-Stop Switch. |
| 7. Drive Belt. | 25. Hearing Tube. |
| 8. Main Shaft Center. | 26. Speaking Tube. |
| 9. Main Shaft Center Set Screw. | 27. Chip Brush |
| 10. Swing-arm Center. | 28. Wax Cylinder, or Blank. |
| 11. Swing-arm Center Set Screw. | 29. Swing-arm Spring Washer. |
| 12. Swing-arm Center Adjusting Screw. | 30. Spring-washer Set Screw. |
| 13. Swing Arm. | 31. Body-holding Screw Washers, (metal and rubber). |
| 14. Lock Bolt. | 32. Main Shaft Pulley. |
| 15. Lift Lever. | 33. Body-holding Screw. |
| 16. Speaker Adjusting Screw. | 34. Top Plate. |
| 17. Speaker Adjusting Screw Lug. | 35. Home Phonograph Body. |
| 18. Speaker Lever. | 36. Back Rod Set Screw. |
| | 37. Main Shaft Pulley Set Screws. |
| | 38. Body Cushions. |

INSTRUCTIONS FOR OPERATING THE EDISON HOME PHONOGRAPH.

Before winding or starting the machine, see that all working parts are free, particularly that there is no dirt or packing in the gear wheels, and that all set-screws are tight. Sometimes these screws work loose from the shock of travel.

The Phonograph, like every other good mechanism, should be clean and free from dust. Instructions as to oiling will be found later in these directions.

See that knife adjusting screw (22) is screwed entirely back, or until the stop pin rests against the casting of the speaker arm, as it always should do except when shaving. This screw controls the shaving knife, and draws it away or forces its cutting edge against the wax cylinder.

As a precautionary measure, it is well to look to the belt (7), the shaft (2), and the speaker arm, before starting the machine. All machines are completely adjusted before shipment from the factory. They will sometimes, though not often, become disarranged in transit. The tension of the belt (7) should be moderate, and the belt-tightening idler pulley (not shown in engraving but easily found on the machine) should be in proper place against the belt. The main shaft (2) turns on centers (8 and 10), between which it should run easily. If centers are too tight they will bind the shaft, while if too loose, the end-shake will destroy the accuracy of the reproduction. There should be no end-shake here. The shaft adjustment is regulated by the adjusting screw (12) on the swing arm center. A simple test is to throw off the belt with the hand, and see if the shaft will spin freely without noise. The main shaft pulley (32) should of course be tight on the shaft. Its set screw (37) regulates this. The main shaft centers are regulated by set screws (9 and 11), as shown in drawing. Care should be taken that the large end of the mandrel (1) does not touch the center lug of the body casting. The thickness

of a piece of paper between the lug and mandrel is sufficient clearance. The speaker arm or carriage of the machine should work free on the back rod (6).

All bearings should be oiled, as mentioned before, and to obtain the best results from the motor the gears must be kept clean, particularly the fine-toothed gear which engages the governor pinion. The governor disc (the flat metal plate against which the horse shoe rocker works) must be oiled occasionally. If necessary to adjust the governor, see to it that there is a slight play between centers. If too tight there, regulation is impaired and efficiency is diminished.

Under no circumstances should the governor disc, described above, touch the adjacent gear.

To Reproduce The first operation will undoubtedly be reproducing. Raise lift lever (15) to its highest point. Push speaker lever (18) to its highest point, against speaker adjusting screw lug (17). Throw down lock bolt (14) and open swing arm (13) wide. Slip the wax cylinder (28), beveled end foremost, upon the tapering brass mandrel (1), and press it firmly, but not too forcibly, into place. Close swing arm and re-lock it. Now place hearing tube (25), or horn, on the speaker tube plate (21), slide speaker arm to point where record appears to begin, and drop lift lever (15), after having first thrown start and stop switch (24) to the left.

With the Automatic Reproducer the following adjustment is unnecessary, as the reproducer ball adjusts itself to the track or groove made by the stylus. With the Standard Speaker (a combination speaker equipped with both recording and reproducing sapphires), it sometimes occurs that clear reproduction is not at first obtained. To obviate this, unscrew the adjusting screw (16) until its point disappears in the lug (17), and while listening press the speaker lever (18) upward with the thumb of the right hand, and with the first and second fingers of the same hand turn the

adjusting screw (16) slowly down until you can hear the record distinctly. This adjustment will bring the reproducer ball into the groove of the record.

Regulation of Speed The speed of the machine in revolutions of the main shaft per minute is regulated by the speed adjusting screw (23). To increase speed screw the nut down, and to decrease it unscrew this nut. Observe this carefully when reproducing music, as a different speed from that at which the music was recorded will reproduce an entirely different pitch. The standard speed at which musical records are taken is about 125 revolutions per minute; talking records, about 80 per minute.

A very good way for the beginner to determine the number of revolutions per minute, is to hold his finger lightly against the main shaft pulley set screw (37), and count the revolutions by his watch, for ten or more seconds.

To Record The machine is at rest. Open speaker clamps (19) and insert recorder with its speaker lever (18) pressed up against lug (17). Press up lift lever (15). Throw down lock bolt (14), and open swing arm (13) wide.

Slip the wax cylinder (28), beveled end foremost, upon the tapering brass mandrel (1), and press it firmly, but not too forcibly into place. Close the swing arm, and re-lock it.

Raise the speaker arm from the straight edge upon which it rests in front, and slide to the left until directly over the beveled end of the cylinder, or the point at which you wish the record to commence. Again lower it to straight edge. Everything is now ready to record.

Start the machine by pushing the switch (24) to the left. The machine is now in motion. Place speaking tube or horn upon the tube plate (21) of the speaker, lower lift lever (15) as far as possible and commence recording. *Further instructions are given*

in Chapter 15, Part II, DICTATING; and Chapter 3, Part III, RECORD MAKING.

Handling Cylinder The wax cylinder, which is somewhat brittle, should be handled gently at first, until the operator becomes practised. See Chapter 13, Part II, BLANKS AND RECORDS.

Do not leave the cylinder upon the brass mandrel (1) of the Phonograph for any length of time when the machine is not in use.

Shaving Cylinders Every Edison HOME Phonograph is equipped with a simple device for shaving off or smoothing blank cylinders, which preparation is necessary before a blank can be used for recording. Here are the instructions for operating the turning rest. Machine is at rest. Wax cylinder firmly set upon mandrel. Hearing tube or horn removed. Speaker lever (18) set as for reproducing, that is, up against lug (17). Fasten back the speaker weight by passing rubber band around lower end of the weight and over the speaker arm.

Lower the speaker arm about over the center of the cylinder, by dropping lift lever (15). Hold the end of the arm down firmly with the thumb and forefinger of the left hand, while with the same fingers of the right, screw down the button (22) which controls the knife bar. This will bring the sapphire shaving knife to the surface of the wax. As the depth of the cut to be taken is very slight indeed, the knife must be set very gently into the wax, as shallowly as possible. The machine is still at rest, with lift lever (15) down. Now raise speaker arm, slide it back to the extreme left, and start the Phonograph.

When the shaving of a cylinder is completed, see that the knife bar is screwed back away from the cylinder, or it will cut the next record that is put on the machine. This is managed by manipulating the button (22). *Further instructions are given in Chapter 14, Part II, SHAVING.*

Oiling Apply oil sparingly but thoroughly to the following parts: back-rod (6), main shaft feed screw (2), main shaft centers (8 and 10), roller on the straight edge, all motor shafts at their bearings, all gear teeth of motor, arbor on which main spring turns, idler pulley occasionally, where tension spring holds it, governor disc, occasionally, winding shaft, if necessary.

No oil should be permitted to get on the belt, and oil must not be smeared on the machine, as it will catch dust and make trouble. When the oil on the gear teeth gets black and dirty, wash it off with benzine before putting on new oil, which apply sparingly. Use best Phonograph oil, to avoid gumming. Above all, keep the machine clean. No mechanism will work perfectly unless free from grit.

CHAPTER IV.

THE EDISON SPRING MOTOR PHONOGRAPH.

ACTUATED by powerful triple springs, which drive the machine through fourteen records with a single winding. No electricity or battery required. Winds noiselessly, runs noiselessly, governs perfectly. Simple, but effective construction, and in every respect a standard machine. Removable hardened steel bearings, belt tightener, and other useful devices. Includes oak body and cover as shown. Finished in black and gilt enamel, with nickel parts. Fitted with instantaneous speaker clamps for instant interchange of speakers.

Weighs 43 pounds, complete, and is particularly recommended for portable service. Size 16½ in. long, 10½ in. wide, 14 in. high.

Two speakers are included, free of charge, with every SPRING MOTOR Phonograph: the Edison Automatic Reproducer and the Edison Recorder; also a sapphire shaving knife, oak body box, oak cover, a 14-inch polished brass horn, two-way hearing tube, a winding crank, an oil can and a camel's hair chip brush.

The SPRING MOTOR Phonograph is shipped only complete as above. The only change made is to substitute a speaking tube for the 14-inch polished brass horn, if so desired.

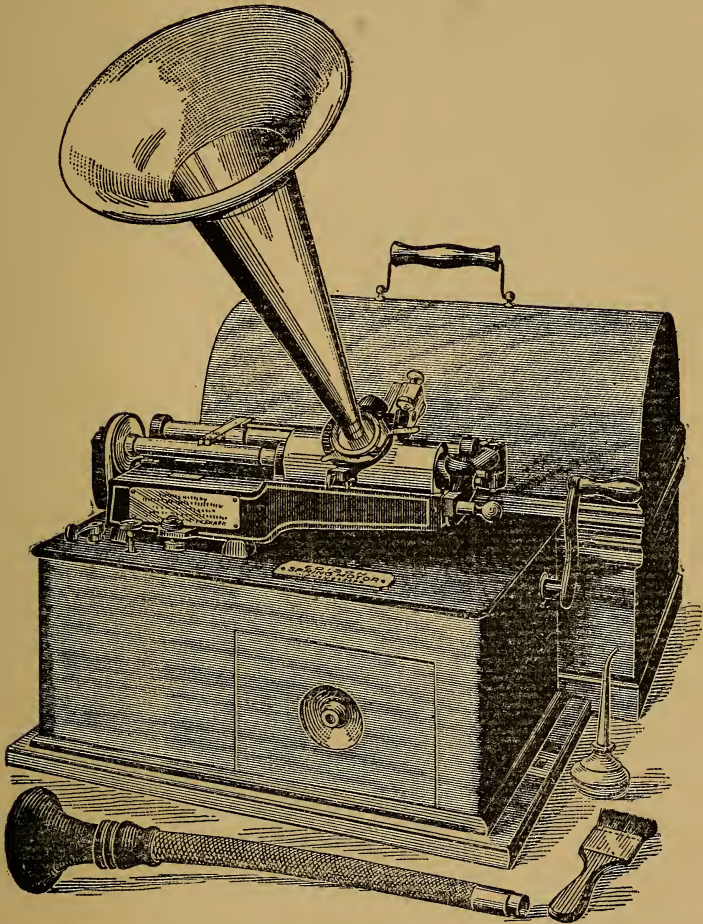

The Edison Spring Motor Phonograph.

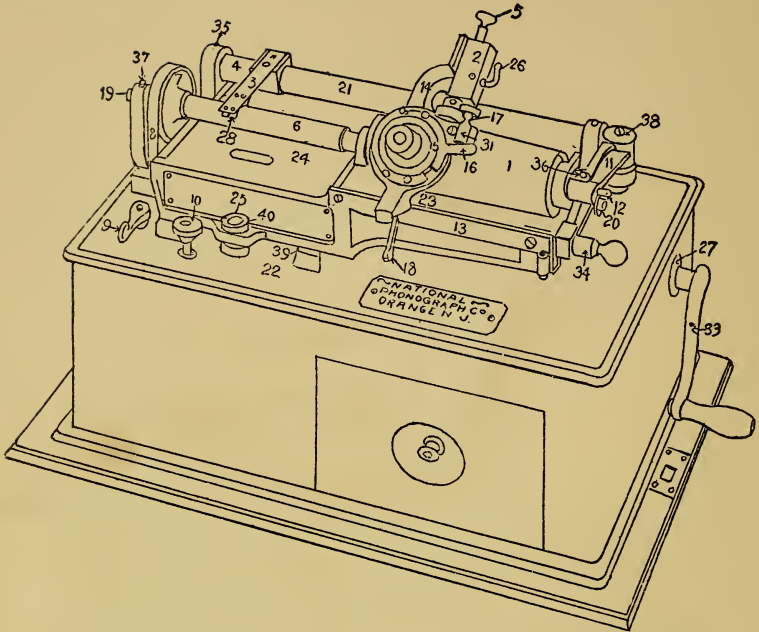

THE EDISON SPRING MOTOR PHONOGRAPH INDEX OF PARTS.

- | | |
|--|---------------------------------------|
| 1. Brass Mandrel to hold wax cylinder. (Always assembled with Main Shaft.) | 19. Main Shaft Center. |
| 2. Turning Rest, to shave cylinder. | 20. Swing-arm Center Adjusting Screw. |
| 3. Feed Spring. | 21. Back Rod Sleeve. |
| 4. Back Rod. | 22. Top Plate. |
| 5. Sapphire Knife Spring Knob. | 23. Speaker Clamps. |
| 6. Main Shaft. (Always assembled with Brass Mandrel.) | 24. Phonograph Body. |
| 7. Main Shaft Pulley. | 25. Body-holding Screws. |
| 8. Drive Belt. | 26. Shaving Knife Lever. |
| 9. Start-and-Stop Switch. | 27. Winding Key Sleeve. |
| 10. Speed Adjusting Screw. | 28. Feed Nut. |
| 11. Swing Arm. | 31. Speaker Adjusting Screw Lug. |
| 12. Swing-arm Center. | 33. Winding Key. |
| 13. Straight Edge. | 34. Lock Bolt. |
| 14. Speaker Arm. | 35. Back Rod Set Screw. |
| 15. Speaker. | 36. Swing-arm Center Set Screw. |
| 16. Speaker Lever. | 37. Main Shaft Center Set Screw. |
| 17. Speaker Adjusting Screw. | 38. Swing-arm Spring Washer. |
| 18. Speaker Arm Lift Lever. | 39. Top Plate Lug. |
| | 40. Body-holding Screw Washers. |

INSTRUCTIONS FOR OPERATING THE EDISON SPRING MOTOR PHONOGRAPH.

Machine at rest. Open speaker clamps (23) and
To Record insert recorder with the speaker lever (16) pressed
 up against lug (31).

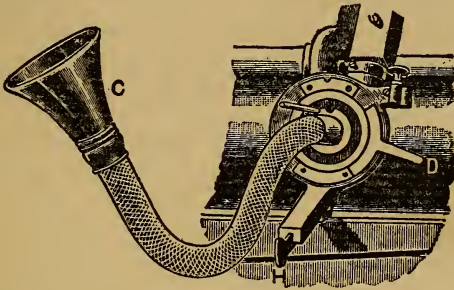

Press up speaker lever D, place the speaking tube C on the
 Phonograph, and lower the lift lever H.

Press up lift lever (18). The *numbers* refer to cut on
 page 70. Throw down the lock bolt (34) and open swing arm
 (11) wide.

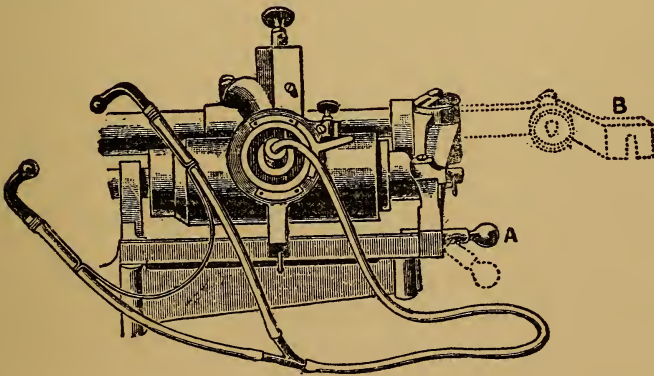

Press down the lock bolt A and open the swing arm B.

Slip the wax cylinder, beveled end foremost, upon the tapering brass mandrel (1), and press it firmly, but not too forcibly into place. The *numbers* refer to cut on page 70.

Close the swing arm and relock it.

Raise the speaker arm (14), an inch is sufficient, from the straight edge (13), upon which it rests in front, and slide to the left until directly over the beveled end of the cylinder, or the point at which you want the record to commence. Again lower it to straight edge and push the speaker lever (16) up as far as it will go.

To Start Start the machine by pushing the switch (9) to the left until it strikes against the pin.
or Stop

Place the speaking tube upon the tube plate, lower the lift lever (18) as far as possible, and commence dictation to the machine. Should it become necessary to pause during the dictation and before the end of the cylinder had been reached, raise lift lever (only) until it closes against the speaker arm; this will disengage the feed nut from the fine thread upon the main shaft, and at the same time raise the recording stylus from the wax.

A fine white shaving will appear on the surface of the cylinder where it has been passed over by the stylus. Remove the speaking tube; raise the speaker arm, and, throwing it back as far as possible, dust off these shavings by holding the camel's hair chip brush against the cylinder, and passing it very slowly from left to right. This operation being completed, the record, as it is now called, is ready to reproduce. *For further instructions see Chapter 15, Part II, DICTATING; also Chapter 3, Part III, RECORD MAKING.*

To Reproduce Press the speaker lever D up, place the hearing tube E on the Phonograph, lower the lift lever H, and turn the adjusting screw F until the proper sound is obtained.

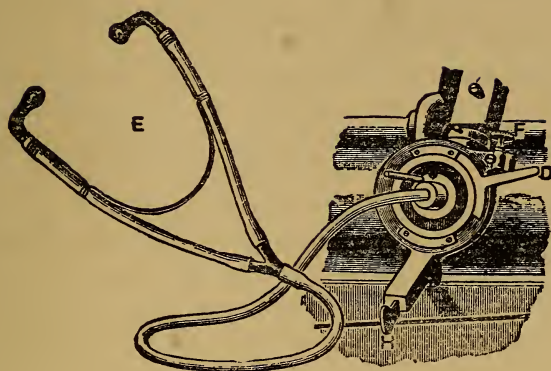

Lift lever (18) up. The *numbers* refer to cut on page 70. Open speaker clamps (23) and insert Automatic Reproducer. Push the speaker lever (16) up against the point of the adjusting screw (17). Now place the hearing tube on the tube plate, and lower the speaker arm opposite the point where the record begins, by dropping the lift lever (18). With the Automatic Reproducer the following adjustment is unnecessary, as the reproducer ball adjusts itself to the track or groove made by the stylus. With the Standard Speaker (a combination speaker equipped with both recording and reproducing sapphires), it sometimes occurs that clear reproduction is not at first obtained. To obviate this, unscrew the adjusting screw (17) until its point disappears in the lug (31), and, while listening with the hearing tube, press the speaker lever (16) upward with the thumb of the right hand, and with the first and second fingers of the same hand turn the adjusting screw (17) slowly down until you can hear the record distinctly. This adjustment will bring the reproducing ball into the groove of the record.

Regulation of Speed

The speed of the machine in revolutions of the main shaft per minute is regulated by the speed adjustment screw (10). To increase speed unscrew this nut, and to decrease it screw the nut down.

Observe this carefully when reproducing music, as a different speed from that at which the music was recorded will reproduce an entirely different pitch. The standard speed at which musical records are taken is about 125 revolutions per minute.

The Turn- ing Rest

Although this device is not, strictly speaking, an important factor in the working of the Phonograph, but merely an appliance for greatly increasing the capacity of the cylinder, still a brief explanation of it, and of the reasons for its use, seems advisable before again passing to the details of instruction.

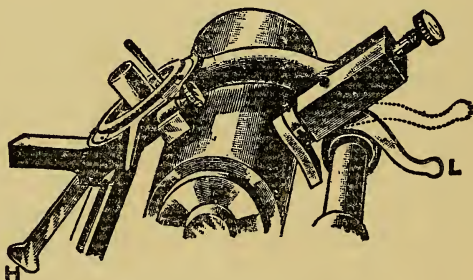

Operating of Turning Rest

Lower the lift lever H, press the knife button until the knife touches the cylinder, and press down the knife lever L, then raise lift lever H. Do not put the Phonograph in motion to shave the cylinder until the knife has been adjusted as above and carried to extreme left end of cylinder, after which lower lift lever H.

Machine at rest. Wax Cylinder firmly set upon mandrel; hearing tube removed; speaker lever (16) pushed up. Fasten

back the speaker weight by passing rubber band around lower end of the weight and over the speaker arm, about where the figures (23) are shown on cut. Or remove speaker, as preferred.

Lower the speaker arm and lever (18) about over the center of the cylinder. Hold the end of the arm down firmly with the thumb and forefinger of the left hand, while with the same fingers of the right *gently* press the button (5) of the knife lever downward and toward the machine. Then press down the knife lever (26) as far as it will go, then close lift lever (18) up into its slot in the speaker arm, slide the arm to the extreme left, again lower the lever (18) and start the machine.

When the turning off of a cylinder is completed, always see that the knife lever (26) is thrown up and back as far as it will go. *Further instructions are given in Chapter 15, Part II, DICTATING; see also Chapter 13, Part II, BLANKS AND RECORDS.*

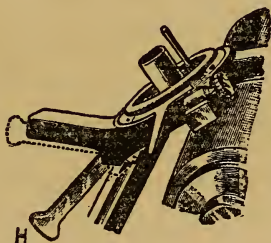

*To Stop
Tempor-
arily*

or to change to another part of the cylinder, raise the lift lever H, without stopping the machine itself.

Oiling

Always keep the entire machine perfectly clean and free from dust. It is an essential to perfect work with any piece of machinery, and the Phonograph is no exception.

Apply oil sparingly but often to the following parts, never over a drop at a time in any one place except where otherwise specified: end bearings of main shaft; thread of main shaft (several drops); back rod, (several drops); straight edge; the two bearings of the winding shaft; the teeth of the ratchet wheel on which pawl works; the inside surface of the friction disc of governor, where the leather touches it; the cupped centers at the end of every gear shaft; the governor shaft, where the governor-disc sleeve moves on the shaft, if dry.

Three places will be found for oiling the barrels and to these places several drops should be applied. (a) The main oil hole is plainly marked on the large barrel. The other two are in the hubs. (b) There is a square opening in the hub of the loose barrel plate at the right hand end. By turning the winding shaft the oil hole can be seen through this opening. (c) The oil hole in the left-hand hub, if not in view, can be found by allowing the machine to run part of one revolution.

Use best Phonograph oil only.

Keep gear teeth free from dirt, to prevent wear and noise. Use benzine for this purpose if necessary, and afterwards apply a drop of oil. Care should be taken not to get any oil upon the drive belt, as it will cause it to stretch and slip loose. Oil only where directed. In smearing oil upon any other part you simply set a trap for dust.

General Instructions Before winding or starting machine, see that all set screws holding bushings, pinions and shafts are tight. They sometimes work loose from the jar of travel.

See that all working parts are free, and particularly that there are no particles of wood or packing material in the mechanism.

The belt should not be too tight, but almost loose enough to slip when main-shaft pulley (7) of the Phonograph is held stationary with the motor running and wound up tight. A new belt

should be brought to proper tension upon setting up machine the first time.

If belt is too tight it will act as a break on the machine. After being once stretched it will require little or no attention.

The tension of the belt is regulated by turning the thumb-screw at the front of the motor below. This belt-tightening screw should not be used when machine is in motion, as there is danger of hitting the moving governor and disarranging the governor springs.

Observe that the rubber cushions on top edge of the body box, and body cushions (39) are in place, and that the main-shaft pulley (7) of the Phonograph is directly above the drive pulley of the spring motor, so that belt runs true. The belt must never run on the flange of the wheel. Care should be observed to keep the rubber cushions and washers of the spring motor in good condition at all times.

The Phonograph should never be shipped with springs wound up.

The sapphires upon the speaker and the turning rest are perfectly adjusted before shipment

The bearings of the main shaft, called the centers, should be snug but not tight. There must be no shake.

The sapphire recording and reproducing points should be kept free from dust and wax scales by brushing, or they may be touched with a little benzine on the finger tip.

Never attempt to slide the speaker arm from side to side without either raising it or closing the lift lever, as you are liable to damage the thread upon main shaft by scraping the twin nuts across it.

Do not remove main shaft from machine unless it becomes absolutely necessary, then use great care in drawing it out to avoid injuring the thread.

CHAPTER V.

THE EDISON CONCERT PHONOGRAPH.

MR. EDISON has perfected the Phonograph. Beginning with the early tin foil machine, Mr. Edison has developed the Phonograph step by step, until to-day the Phonograph stands on the pinnacle of perfection. It perfectly reproduces human voice; just as loud—just as clear—just as sweet. It duplicates instrumental music with pure-toned brilliancy and satisfying intensity. Used with Edison Concert Records, its reproductions are free from all mechanical noises; only the music or voice is heard. It is strong and vibrant enough to fill the largest concert hall. It is smooth and broad enough for the parlor. It is made with the careful precision that characterizes all Genuine Edison Phonographs. It is made to reflect credit and to uphold the fame of the name of the man who stands behind it.

The Edison Concert Phonograph is actuated by powerful triple springs. It plays six to eight concert records with a single winding. It is finished in black and gilt enamel, with nickel parts. It has a polished oak body box and carrying cover. Size, 12 x 17 x 17 inches. Weighs 51 pounds. Size of mandrel, 4½ inches diameter by 5 inches long. Every Edison Concert Phonograph includes, free of charge, an automatic reproducer, a recorder, a sapphire shaving knife, oak body box and cover, a

24-inch brass horn and stand, winding crank, speaking tube, oil can and chip brush.

The Edison Concert Phonograph is built on the same body as the Edison Spring Motor Phonograph described in the previous chapter. The Phonograph top is also exactly the same, except that the parts are larger, to admit the swing of the five-inch record.

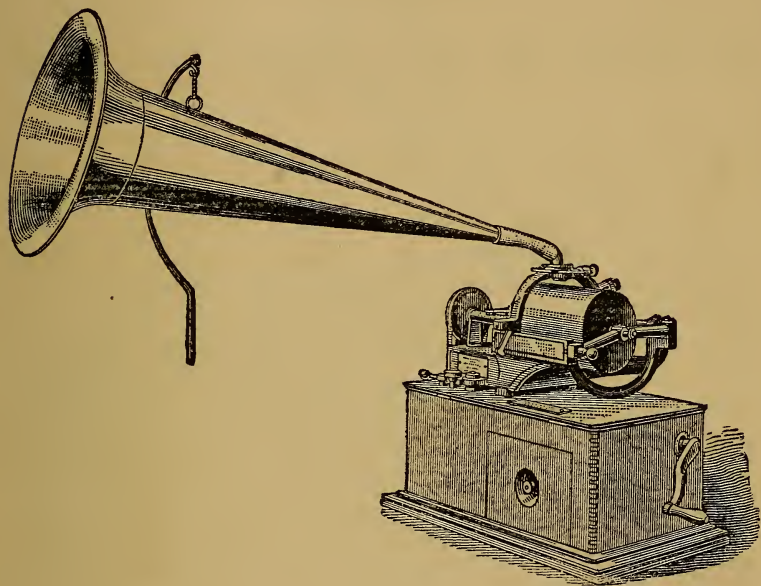

*General In-
structions for
Operating
this Machine*

are the same as in the preceding chapter. The following is the only point that it is necessary to emphasize especially: in closing swing arm of the Edison Concert Phonograph, see that the pin on swing arm enters hole on straight edge casting. Press the arm firmly with thumb, at the same time locking the lock bolt with first two fingers of same hand.

CHAPTER VI.

THE EDISON "M" AND "E" ELECTRIC PHONOGRAPHS.

THE EDISON "M" ELECTRIC PHONOGRAPH, the most approved type of ELECTRIC Phonograph, is equipped with electric motor (wound for battery) and governor, and is fitted with instantaneous speaker clamps, for instant interchange of speakers. It sets in an oak body box. Weighs 65 pounds. Finished in black, gold and nickel. Size, 20 in. long, 9½ in. wide and 11 in. high. A Battery is not a part of the Phonograph, but is an independent apparatus. Storage or primary (chemical) battery may be used. The motor requires a steady current of 2½ volts and 2 amperes. Its uniform action and continuous power supply recommends the "M" ELECTRIC Phonograph for all occasions where these requisites are desired.

Two speakers are included, free of charge, with the "M" ELECTRIC Phonograph: the Edison Automatic Reproducer and the Edison Recorder; also a sapphire shaving apparatus, a 14-inch polished brass horn, a two-way hearing tube, an oil can and a camel's hair chip brush. The only change made in the above equipment, is to substitute a speaking tube for the 14-inch polished brass horn, if so desired.

The Edison "E" ELECTRIC Phonograph. In general appearance and equipment this Phonograph is exactly the same as the "M" Electric, but is furnished with an electric motor wound to

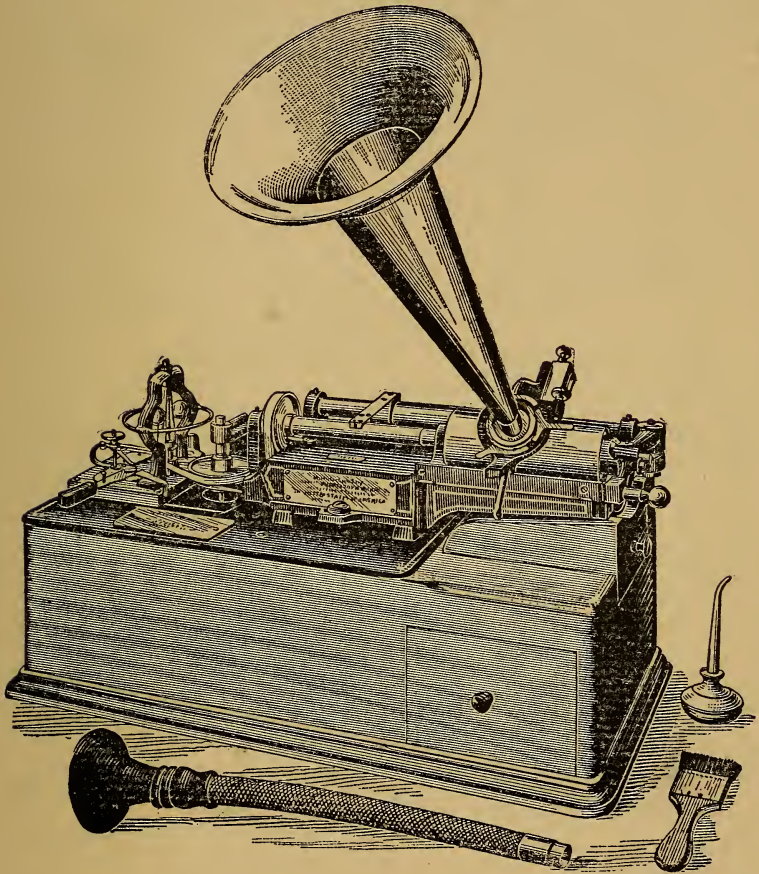

The Edison "M" and "E" Electric Phonographs.

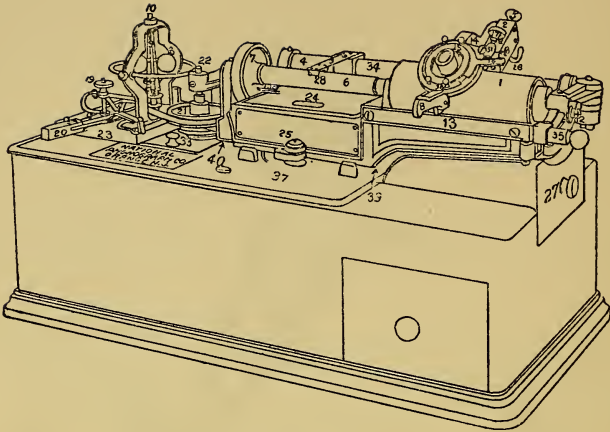

THE EDISON "M" AND "E" ELECTRIC PHONOGRAPHS.

INDEX OF PARTS.

- | | |
|---|----------------------------------|
| 1. Brass Mandrel to hold wax cylinder. (Assembled with Main Shaft.) | 19. Governor Adjustment Screw. |
| 2. Turning Rest, to shave cylinders. | 20. Governor Brake, or Switch. |
| 3. Feed Spring. | 21. Armature Pulley. |
| 4. Back Rod. | 22. Armature Shaft Center. |
| 5. Sapphire Knife Spring Knob. | 23. Governor Block. |
| 6. Main Shaft. (Always assembled with Brass Mandrel.) | 24. Phonograph Body. |
| 7. Main Shaft Pulley. | 25. Body-holding Screws. |
| 8. Governor Frame. | 26. Shaving Knife Lever. |
| 9. Governor Shaft. | 27. Chip Box. |
| 10. Governor Shaft Center. | 28. Feed Nut. |
| 11. Swing Arm. | 31. Speaker Adjusting Screw Lug. |
| 12. Swing-arm Center. | 33. Top Plate Cover. |
| 13. Straight Edge. | 34. Back Rod Sleeve. |
| 14. Speaker Arm. | 35. Lock Bolt. |
| 15. Speaker. | 36. Governor Contact. |
| 16. Speaker Lever. | 37. Top Plate. |
| 17. Speaker Adjusting Screw. | 38. Speaker Clamps. |
| 18. Speaker Arm Lift Lever. | 39. Belt-tightening Screw. |
| | 40. Idler Pulley. |
| | 41. Governor Top Brush. |

run on the 110 to 120 volt Edison Direct Current. It is the most convenient style of Phonograph made. The power is both continuous and handy, as connecting wires need only to be attached to the nearest electric light connection. It is equipped with resistance block fitted with lamps, attaching plug and cord.

INSTRUCTIONS FOR OPERATING THE EDISON "M" AND "E" ELECTRIC PHONOGRAPHS.

The "E" electric is in every way similar to the "M" electric, with the single exception of the motor, which is wound differently. *For instructions as to care of batteries, renewals and recharging, see Chapter II, Part II, BATTERIES.*

Machine at rest. Open speaker clamps (38) and *To Record* insert recorder with the speaker lever (16) pressed up against lug (31).

Press up speaker lever D, place the speaking tube C on the Phonograph, and lower the lift lever H.

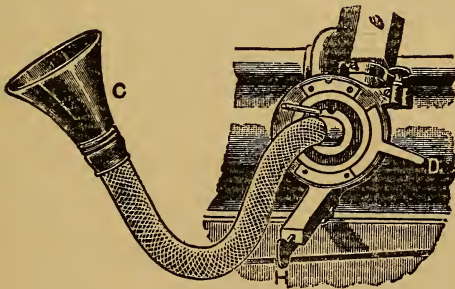

Press up lift lever (18). The *numbers* refer to cut on page 82. Throw down the lock bolt (35) and open swing arm (11) wide.

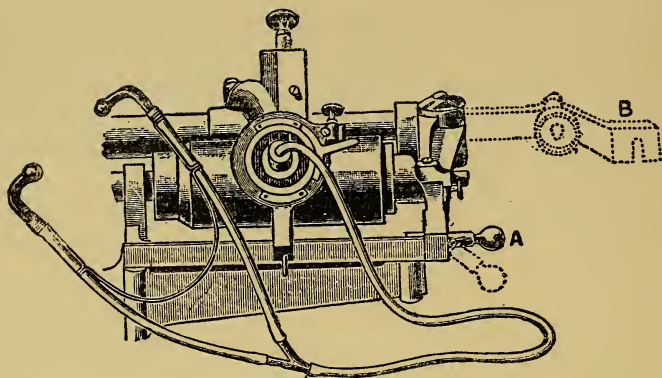

Press down the lock bolt A and open swing arm B.

Slip the wax cylinder, beveled end foremost, upon the tapering brass mandrel (1), and press it firmly, but not too forcibly into place. The *numbers* refer to cut on page 82.

Close the swing arm and relock it.

Raise the speaker arm (14), an inch is sufficient, from the straight edge (13), upon which it rests in front, and slide to the left until directly over the beveled end of the cylinder, or the point at which you want the record to commence. Again lower it to straight edge and push the speaker lever (16) up as far as it will go.

*To Start
or Stop*

Move the brake handle to the left or right as the case may be. Obtain desired speed by turning governor adjusting screw M (see page 85).

Start the machine by pushing the brake handle (20) to the left until it strikes against the pin.

Place the speaking tube upon the tube plate, lower the lift lever (18) as far as possible, and commence dictation to the machine. Should it become necessary to pause during the dictation and before the end of the cylinder has been reached, raise

lift lever (only) until it closes against the speaker arm ; this will disengage the feed nut from the fine thread upon the main shaft and at the same time raise the recording stylus from the wax.

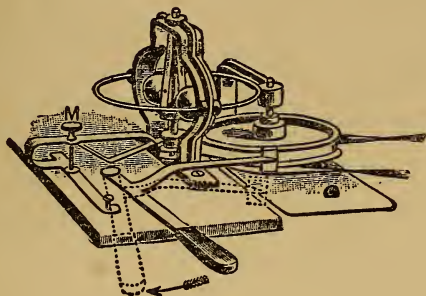

A white shaving will appear on the surface of the cylinder where it has been passed over by the stylus. Remove the speaking tube ; raise the speaker arm, and, throwing it back as far as possible, dust off these shavings by holding the camel's hair chip brush against the cylinder, and passing it very slowly from left to right. This operation being completed, the record, as it is now called, is ready to reproduce. *Further instructions are given in Chapter 15, Part II, DICTATING ; also Chapter 3, Part III, RECORD MAKING.*

To Reproduce Press the speaker lever D up, place the hearing tube E on the Phonograph, lower the lift lever H, and turn the adjusting screw F until the proper sound is obtained.

Lift lever (18) up. The *numbers* refer to cut on page 82. Open speaker clamps (38) and insert automatic reproducer. Push the speaker lever (16) up against the point of the adjusting screw (17). Now place the hearing tube on the tube plate, and lower speaker arm opposite the point where the record begins, by dropping the lift lever (18). With the Automatic Speaker the

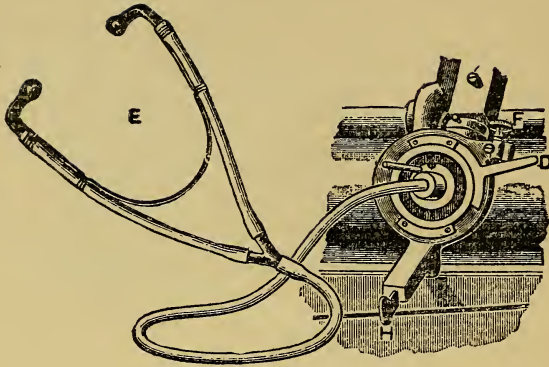

following adjustment is unnecessary, as the reproducer ball adjusts itself to the track or groove made by the stylus. With the Standard Speaker (a combination speaker equipped with both recording and reproducing sapphires), it sometimes occurs that clear reproduction is not at first obtained. To obviate this, unscrew the adjusting screw (17) until its point disappears in the lug (31) and, while listening with the hearing tube, press the speaker lever (16) upward with the thumb of the right hand, and with the first and second fingers of the same hand turn the adjusting screw (17) slowly down until you can hear the record distinctly. This adjustment will bring the reproducing ball into the groove of the record.

Regulation of Speed

The speed of the machine in revolutions of the main shaft per minute is regulated by the speed adjustment screw (19). To increase speed unscrew this nut, and to decrease it screw the nut down.

Observe this carefully when reproducing music, as a different speed from that at which the music was recorded will reproduce an entirely different pitch. The standard speed at which musical records are taken is about 125 revolutions per minute.

The governor speed (top) brush (41) on the speed-adjusting spring should rest against the under side of the contact disc (35) only. It must never touch the hub of the disc.

The Turning Rest Although this device is not, strictly speaking, an important factor in the working of the Phonograph, but merely an appliance for greatly increasing the capacity of the cylinder, still a brief explanation of it, and of the reasons for its use, seems advisable before again passing to the details of instruction.

Operation of Turning Rest Lower the lift lever H, press the knife button until the knife touches the cylinder, and press down the knife lever L, then raise lift lever H. Do not put the Phonograph in motion to shave the cylinder until the knife has been adjusted as above and carried to extreme left end of cylinder, after which lower lift lever H.

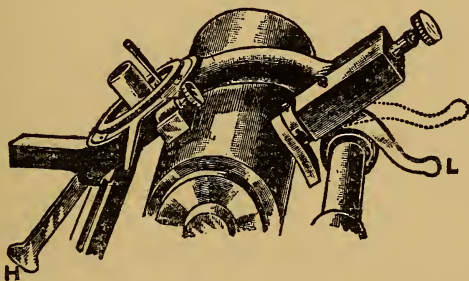

Machine at rest. Wax cylinder firmly set upon mandrel; hearing tube removed; speaker lever (16) pushed up. Fasten back the speaker weight by passing rubber band around lower end of the weight and over the speaker arm, about where the figures (38) are shown on cut. Or remove speaker, as preferred.

Lower the speaker arm and lever (18) about over the center of the cylinder. Hold the end of the arm down firmly with the thumb and forefinger of the left hand, while with the same fingers

of the right *gently* press the button (5) of the knife lever downward and toward the machine. Then press down the knife lever (26) as far as it will go, then close lift lever (18) up into its slot in the speaker arm, slide the arm to extreme left, again lower the lever (18) and start the machine.

When the turning off of a cylinder is completed, always see that the knife lever (26) is thrown up and back as far as it will. *Further instructions are given in Chapter 14, Part II, SHAVING.*

Handling the Cylinder The wax cylinder, which is somewhat brittle, should be handled gently at first, until the operator becomes practised. *See Chapter 13, Part II, BLANKS.*

To Stop Temporarily or to change to another part of the cylinder. Raise the lift lever H, without stopping the machine itself.

Oiling Always keep the entire machine perfectly clean and free from dust. It is an essential to perfect work with any piece of machinery, and the Phonograph is no exception in this respect.

Phonograph oil should be applied *sparingly* every two or three days to the following parts: "Oil hole," back of governor block; base of governor shaft; small hole in top of governor frame; top center bearing of armature shaft; bearings of idler pulleys under which the main belt turns; end bearings of main shaft; thread of main shaft; back rod; a little upon the straight edge. Care should be taken not to get any oil upon the belts, as it makes them slip and stretch loose very quickly. Use as little oil as possible at the top of the governor, as spreading down it gets upon the contact and tends to make the motor govern badly. Oil only where directed. In smearing it upon any other part you simply set a trap for dust.

General Instructions TO TIGHTEN MAIN BELT.—Loosen the two body-holding screws (25) which fasten the machine to the top plate, and turn belt-tightening screw (39) which is under the mandrel, inward.

TO TIGHTEN GOVERNOR BELT.—Slightly loosen the four screws which hold the wooden governor block (23) to the top plate, the holes for which are slotted, and slide the entire governor to the left until sufficient tension is obtained.

Belts should be kept moderately tight to prevent slipping ; if too tight extra power is required to start the machine.

The sapphires upon the speaker and the turning rest are perfectly adjusted before shipment.

The copper brushes, both motor and governor, should be kept clean by the use of benzine. *Never* oil them, or the commutator or contact on which they rest. These parts must be perfectly dry and bright. When necessary to clean, use care not to spread or displace the fine wires of the brushes.

The bearings of the shafts, called the centers, should be snug but not tight. There should be no shake.

Keep battery wire contacts bright and clean, and see that the wire is held tightly at its terminals.

The sapphire recording and reproducing points should be kept free from dust and wax scales by brushing, or they may be touched with a little benzine on the finger tip.

When the machine is used indiscriminately for both recording and reproducing, do not leave the speaker lever (16) down except while recording.

Never attempt to slide the speaker arm from side to side without either raising it or closing the lift lever, as you are liable to damage the thread upon main shaft by scraping the feed nuts across it.

To use your power economically, be sure to cut off current from the motor when not in use. Do not allow any metallic sub-

stance to come in contact with either the speaker sapphires or the knife.

Do not remove main shaft from machine unless it becomes absolutely necessary, then use great care in drawing it out to avoid injuring the thread.

CHAPTER VII.

THE EDISON "M" CONCERT PHONOGRAPH.

THIS consists of a CONCERT body (see description of the Concert Phonograph, Chapter 5, Part II), mounted on an "M" electric motor, as described in preceding chapter. It rests in an oak body box 20 inches long and $9\frac{1}{2}$ wide. It stands 14 inches high, weighs 73 pounds, and is finished in black, gold and nickel. Is equipped with electric motor (wound for battery) and governor, and is fitted with instantaneous speaker clamps, for instant interchange of speakers. The battery is not a part of the Phonograph, but is an independent apparatus. Storage or primary (chemical) battery may be used. The motor requires a steady current of $2\frac{1}{2}$ volts and 2 amperes. On account of its uniform action, continuous power supply, volume of sound, true tone quality, and distinct articulation, the "M" CONCERT Phonograph is recommended for important work where the highest results are sought.

Two speakers are included, free of charge, with the "M" CONCERT Phonograph; the Edison Automatic Reproducer and the Edison Recorder: also a sapphire shaving apparatus, a 24-inch polished brass horn and stand, an oil can and a camel's hair chip brush.

*General
Instructions
for
Operating*

this machine are the same as in the preceding chapter. The following is the only point that is necessary to emphasize especially: in closing swing arm of the Edison "M" CONCERT Phonograph, see that the pin on swing arm enters hole on straight edge casting. Press the arm firmly with thumb, at the same time locking the lock bolt with first two fingers of same hand.

CHAPTER VIII.

THE EDISON "H" COIN SLOT PHONOGRAPH.

AN automatic Coin Slot Phonograph that is almost as effective as the higher priced machines. The machine is a HOME, requiring to be wound by the customer each time a coin is dropped in. It is simple in construction, easy of adjustment and costless to maintain. Every detail in construction has been worked out with the greatest care and precision. The slot mechanism is an improvement over any other on the market, and is solid and substantial in every particular.

Equipped with a winding stop, thus preventing overwinding by careless customers. The slot locks automatically while the machine is playing. The only care it needs is the occasional changing of the record. Most of the machines are operated by a nickel; but machines to be operated by special coins are also to be had. Base measures $18\frac{1}{2}$ x 12 inches. Height, 21 inches. Weight, 45 pounds. Is equipped with a 14-inch brass horn and Edison Automatic Reproducer.

INSTRUCTIONS FOR SETTING UP AND ADJUSTING THE "H" COIN SLOT PHONOGRAPH.

First open the large box containing the cabinet. Set it on a convenient stand or table. Unlock the lower swinging front. Pull

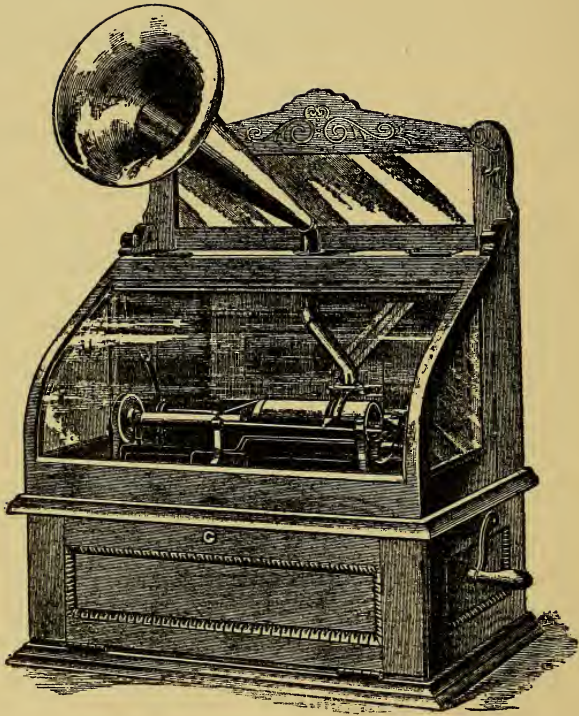

The Edison "H" Coin Slot Phonograph.

out the brass knob to release the catch that fastens the glass cover. Raise glass cover till it is held back, wide open, by the swinging catch on the left.

Be sure to remove any dust or excelsior packing that may have accumulated, from all parts of cabinet. The cabinet is now ready to receive the movement.

Unpacking Next open the smaller box containing the movement. You will see for yourself, afterward, the delicacy of the mechanism. We tell you about it now so that no jamb, or knock, or twist, or blow shall be given to the coin chute or tripping mechanism or any other parts. The greatest possible care is exercised in packing and shipping this movement. It is first encased in a temporary stand or cabinet, which in turn is floated in a heavy outer packing case with thick layers of packing between the two boxes, thus making it impossible for the movement to be damaged in transit. Remove the inner cabinet from the packing box, side marked *top* up, and remove the wood screws. This allows the upper half of cabinet to be taken off, leaving the movement screwed to the lower half of the stand, with the sides exposed. It leaves the factory already assembled (except coin chute as noted hereafter) ready to run, and thoroughly tested.

Make all adjustments in the order given in the following instructions: don't touch this piece or that piece, before you have followed out exactly the directions for each part. Study each part carefully and intelligently as you adjust it, and you will find no difficulty in setting up the whole Phonograph. Once properly assembled, the coin slot mechanism works perfectly, and, if carefully treated, requires no attention other than changing the record and emptying the money drawer.

Accidents and misuse, however, are contingencies that must be considered; and the following suggestions and explanations are made so that you may be enabled to readjust the machine yourself in case of anything happening to it.

The Coin Slot Mechanism

Place the mechanism on a table before you, still in its temporary stand. Study it carefully. Don't attempt to put it into the cabinet until you have looked at it carefully from the front, from behind, on all sides. The stand is purposely made open front and back, so that the working of all parts may be watched and studied. This open unobstructed view will enable you to see how simple and perfect the mechanism is.

Untie the parts carefully that are fastened with cord, oil gears and centers as instructed in DIRECTIONS FOR OPERATING EDISON HOME PHONOGRAPH. The Coin Slot Phonograph is built up from the HOME, so you must first follow the general HOME instructions down to TO REPRODUCE.

The polished nickeled coin chute with sliding sleeve is packed with the horn and other small parts in the large box, inside the cabinet. Adjust the coin chute A (Fig. 1.) to the projecting piece B at the back of the movement, with the screw that is tied to it.

Particular care must be observed that the coin chute is set so that it does not touch the two prongs C and D on the coin lever.

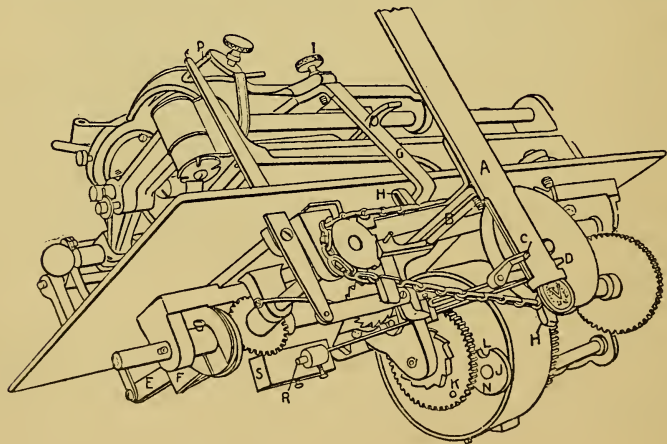

The coin lever must play freely, without rubbing or even touching the chute. Any friction at this point will throw the working of the machine entirely out.

The winding is the next operation. At the first turn of the key, the speaker arm is lifted by the action of the friction lever E (Fig. 1.) This friction lever plays upon the winding shaft. The proper amount of friction is regulated by the brass clamp F, by means of the adjusting screw as shown on the clamp. It should be just tight enough to lift up the speaker arm, and keep it raised during the entire operation of winding. If too tight it makes the machine wind hard.

The Return Mechanism The raising of the speaker arm plays two important parts; 1st, disengaging the feed nut from the main shaft, and 2d, putting the return mechanism into operation. The lever G (Fig. 1.) comes into contact with the lugs H H on the sprocket chain, which carries the speaker arm back to the proper starting point. This is easily determined by shifting the lever G back and forth on the speaker arm, and then clamping it firmly by the thumb nut I in upper end, so that the reproducer will be exactly over the beginning of the record at the moment the sprocket lugs leave the lever G. This return movement also unlocks the slot in the cabinet, as explained under heading "Starting."

The Stop Winding Mechanism is shown in Fig. 2. This is the device by which overwinding is avoided, thus prolonging the life of the mainspring. Fig. 3. shows the relative position of the stop J and the pin K, after the operation of winding. The pin K is against the stop J, thus stopping the winding. Note that the pin K is on the winding gear and the stop J is on the spring barrel. While winding, the gear wheel and pin K revolve in the direction shown by arrows, the spring barrel remaining stationary. Three and a half turns of the winding key make the gear wheel and pin K revolve once. On the first revolution

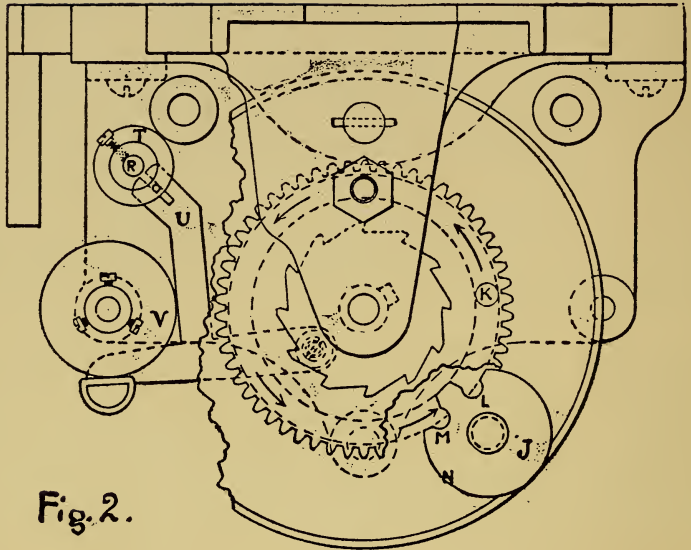

Fig. 2.

the stop J presents the slot L, to the pin K, thus allowing the winding to continue. On the 2nd revolution the stop J presents the slot M to the pin K, thus continuing the winding. On the 3rd revolution J is stopped by the pin K coming in contact at N. The correct adjustment of stop J must be such that it does not stop the winding until the spring is wound to its full capacity (but not *too* tight). After winding, make sure that the spring *is* wound fully by looking into the spring barrel on its left side, from the front of the mechanism.

*Adjustments
of
Stop Winding
Mechanism*

As the best results are obtained when the full force of the spring is exerted upon the mechanism, it is highly important that the spring should be coiled up tight in the spring barrel, or nearly so. If such is not the case, the stop J (Fig. 2.) has been moved or jarred by shipment, and has stopped the winding

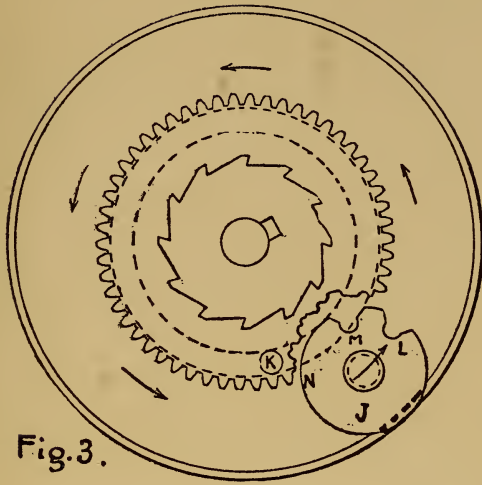

Fig. 3.

operation with the spring not fully wound. To remedy, turn the stop J on its central pivot so that the pin K will come into slot M, thus permitting another revolution of the winding gear and pin K, equal to $3\frac{1}{2}$ turns of the winding key.

Should the opposite happen, that is, the spring become fully wound before the pin K touches the stop J, at the point N, let the machine run until the stop J *passes the pin K*, then turn the stop to position shown in figure 3.

Should the return mechanism fail to return, or the coin in the slot fail to start the machine, or the record stop playing half way through, the remedy is simple. Remove the record and revolve the shaft in the opposite direction, or toward the front, until the stop J disengages itself from the pin K, so that it can be adjusted as in Fig. 2; that is, so that the pin K fits into the slot M, thus permitting another revolution of the winding gear, equal to $3\frac{1}{2}$ turns of the key.

The importance of these winding adjustments cannot be emphasized too much.

As noted in the instruction card, the nickel is dropped into the slot *after* the machine is wound. This prevents the possibility of "working" the machine twice with one nickel. The coin is caught on the prongs C D (Fig. 1) of the coin lever, its weight acting on a series of levers (as explained later under the heading "Stopping"), thus releasing the governor brake and starting the mechanism. The nickel stays on the coin lever until the record is played through, when it is released and falls into the money drawer. The machine is so planned that you *cannot* wind it as long as the coin remains on the coin lever. Once started by the nickel, it plays the record through. You cannot stop it, you cannot rewind it. Not until the nickel drops out of the coin lever will the machine stop. It is then ready to wind again.

Slot Locking Device The starting of the machine and the movement of the speaker arm locks the slot in the cabinet instantly. The lug O (Fig. 1) on the lever G on the speaker arm releases a spring lever attached to the cabinet work, and throws a pin across the slot, thus making it impossible to drop in another nickel until the machine is rewound. As explained under its heading, the winding operation carries the speaker arm back to its original position; and by so doing, unlocks the slot and the machine is ready for the next nickel.

It is important that the slot locking device is always in working order; for if it gets out of adjustment and allows of another nickel being dropped before the machine is rewound, or while it is winding, it locks the winding shaft immediately. Should this occur, trip the prong C on the rear end of the coin lever. This throws the nickel out, unlocks the winding shaft, and permits the machine to be wound properly.

Stopping To stop the machine when the record is played to the end, adjust the wire P (Fig. 1) by means of the thumb screw in the speaker arm, so that it just comes into contact with the lever Q at the proper time, thus throwing the nickel out of the coin lever and stopping the mechanism. The coin lever is balanced on the shaft R (See also Fig. 2). The adjustment of the balance is made by moving the weight S (Fig. 1) on the front end of the coin lever. On the other end of shaft R (Fig. 2) near the governor is a disc T with a small pin which works in a slot in the brake lever U. This brake lever comes into contact with the governor disc V, thus stopping the machine.

To Adjust While the nickel is on the coin lever the end of the brake lever U (Fig. 2) *should just clear* the governor disc V, thus allowing it to revolve freely. When the nickel drops into the coin drawer, the weight S (Fig. 1) tips down its end of the coin lever, causing shaft R (Fig. 2) to turn, thus throwing pin in disc T upward, causing the brake lever U to press upward upon the governor disc V. If the pressure is not sufficient to stop the governor immediately, loosen the set screw in T, and turn disc toward the front, until the proper pressure of brake on governor disc is obtained.

When you have mastered the movement thoroughly, shift the machine to the permanent cabinet. Take out the screws from top plate, and lift the machine out of the temporary stand, very carefully. **DON'T SET THE MECHANISM DOWN AGAIN, BUT PLACE IT IMMEDIATELY** into the cabinet, taking the same care that none of the parts and especially the coin chute touches the woodwork as you set it into place. See that the two screw holes in the top plate correspond with the holes in the cabinet. Screw down firmly.

The Coin Chute on the mechanism is connected with the short chute attached to cabinet by the sliding sleeve on the upper end of coin chute.

*Winding
Key*

On the inside of the lower cabinet, to the right, just over the money drawer, is a flat iron pawl. Slide the key through the hole in the cabinet, on to the winding shaft, lifting the pawl at the same time. When the key is in its proper position, the pawl drops into the groove on key. Thus the key is free to turn, but absolutely unremovable from the outside.

CHAPTER IX.

THE EDISON "M" COIN SLOT PHONOGRAPH.

THIS outfit consists of an Edison "M" ELECTRIC Phonograph with Automatic Reproducer, hearing tube, 24-inch polished brass horn and horn support, automatic slot attachment, storage battery and cords. The Phonograph mechanism and the battery are enclosed in a substantial oak cabinet, as shown. Weighs 130 lbs., height, 53in.; occupies a floor space of $27\frac{1}{2}$ x $16\frac{1}{2}$ in. These machines when placed in a store, hotel, or place of amusement usually prove a source of great profit to their fortunate owner. Usually operated by a nickel. Machines to be operated by special coins are also to be had. As they are actuated by electricity, no winding is necessary. They run noiselessly and continuously, and are a safe and profitable investment.

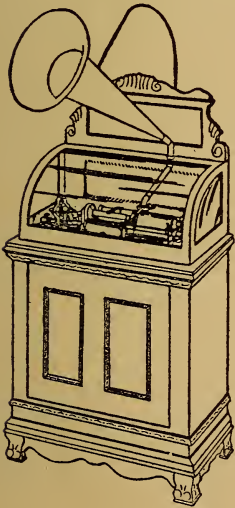

INSTRUCTIONS FOR OPERATING THE EDISON "M" COIN SLOT
PHONOGRAPH.

The Phono- is almost identical with the "M" Electric, and the
graph same instructions apply as have been set forth
Mechanism already in Chapter 6, Part II.

The Coin is so nearly like that used in the "M" Concert Coin
Slot Slot Phonograph (described in the following chapter)
Mechanism that the direction for operating apply word for word.

CHAPTER X.

THE EDISON "M" CONCERT COIN SLOT PHONOGRAPH.

THIS outfit consists of a CONCERT Body, as described in Chapter 5, Part II, mounted on an "M" ELECTRIC motor.

It is equipped with an Automatic Reproducer, automatic slot attachment, hearing tube, 24-inch polished brass horn and horn support, together with complete storage battery and cords. The Phonograph mechanism and the battery are enclosed in a handsome oak cabinet, similar in appearance to the "M" Coin Slot Cabinet, described in previous chapter. It stands 55 inches high, and occupies a floor space of 28 by 18 inches. The illustration shows the door removed, in order to display interior of the cabinet.

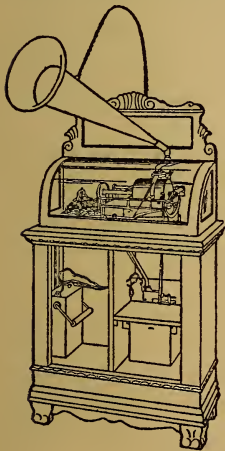

As it is actuated by electricity, no winding is necessary. Runs continuously and without noise. Usually operated by a nickel. Machines to be operated by special coins are also to be had.

As a novelty, the Edison Concert Coin Slot Phonograph is the most at-

tractive and wonderful musical and talking machine ever put before the public.

INSTRUCTIONS FOR OPERATING THE EDISON "M" CONCERT COIN SLOT PHONOGRAPH.

The Phonograph Mechanism is almost the same as the "M" Electric, and the same instructions apply as have been already given in Chapter 6, Part II.

The Coin Slot Mechanism When the coin is dropped in the slot X it travels down the chute Y and stops at a point A under the cover Z. This point A is between two slide pieces, B and C, the ends of which project beyond the cover Z.

The weight of the coin against slide piece B overcomes the pressure of the copper spring D, which is attached to the slide piece B, and presses B against the copper contact E, which makes an electrical connection, thus starting the motor.

The speaker arm will now travel over the wax cylinder until the projection (on which the lift lever works) comes into contact with the adjustable dog F on the horizontal rod G. When this dog F is adjusted properly, the speaker arm projection when stopped by it, will come just under the hook J on the vertical rod K. Note that this rod K extends through the base into the lower cabinet.

On the left end of the rod G is the pulley P of the the return attachment and clutch H. When the moving speaker arm engages dog F, which is firmly fastened to rod G, the entire rod slides to the right, slowly propelled by the moving speaker arm, thus engaging the clutch H with the pulley P.

The return attachment will now wind up the cord until the lever I raises the speaker arm (thus lifting the speaker from the record) and, by striking against the hook J, lifts the vertical rod K, causing the lever LL (in the lower cabinet) to pull out the slide C, releasing the coin which drops into the drawer M.

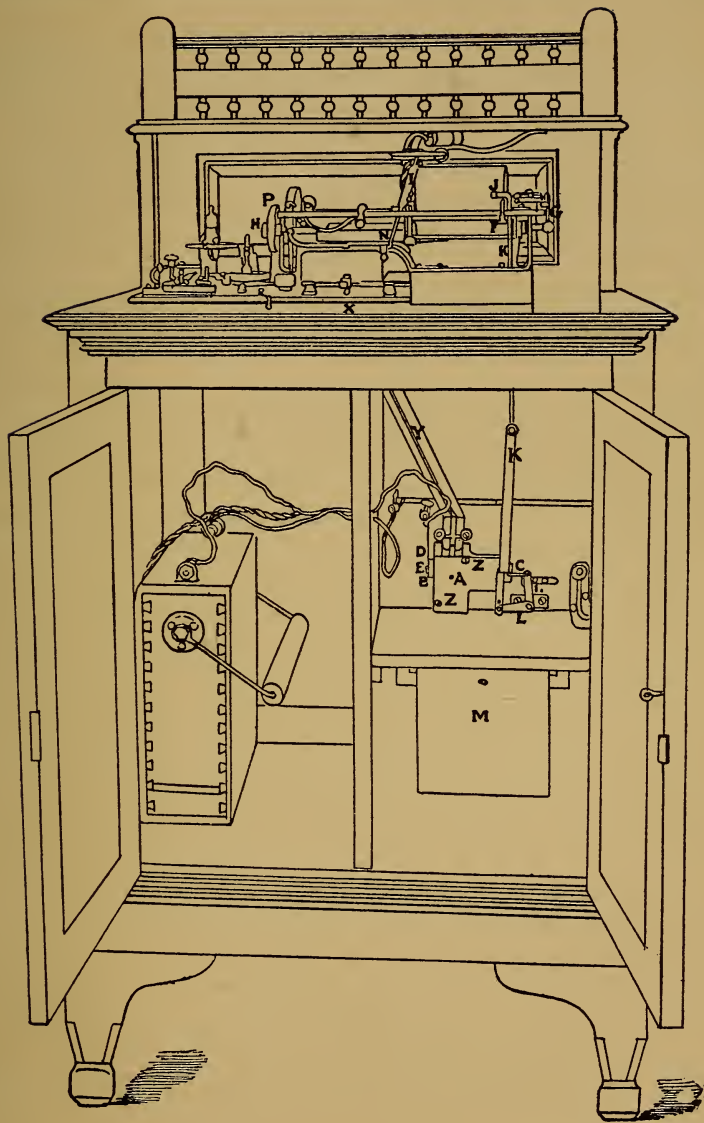

The pressure of the coin against the slide B being now removed, the copper spring D forces the slide back to its original position, breaking the electrical connection and stopping the motor, the momentum of which will carry the speaker arm back, or nearly back to the point of starting. The slide C returns to its original position by the weight of the rod K pressing down upon it. When another coin is dropped in, the speaker arm is carried fully back against the dog N, which disengages the clutch H from the pulley P, thus allowing the cord to unwind, lowering the speaker arm and starting it off at the beginning of the record. The dog N should be located so that it will strike the lever I (thus disengaging the pulley on the return attachment) when the speaker in the speaker arm is exactly at the starting point.

The automatic parts are all adjustable, and it only needs careful attention to the above instructions, together with watching and studying the parts, to obtain absolutely perfect results.

CHAPTER XI.

BATTERIES.

Primary Batteries When the first "M" Electric Phonographs were put on the market they were supplied with the Grenet type of primary battery, using bi-chromate of potash. There were many objections to this type of battery; chief among them its short life, and consequent expense, its uncleanness and the care needful to keep it in order. Other styles of primary batteries have come and gone. Some have been more successful than others by lacking one or more of the above objections. Not until the appearance of the Edison-Lalande Battery however, did the problem of efficiency, economy and cleanliness appear to be anywhere near a practical solution. Here are the principal points in favor of the Edison-Lalande Batteries; points that place them far and away in the lead of all other primary batteries for use with the Edison "M" Electric Phonograph :

- 1st. High and constant AVAILABLE electromotive force.
- 2d. No local action, and therefore, no loss of energy, while the cell is idle—the chemical action in cell is less than one per cent. per month.
- 3d. Extremely low internal resistance.
- 4th. Heavy current delivery, absolutely constant.
- 5th. Cheap materials for renewals, easily obtained. The

elements employed in the Edison-Lalande cell are zinc, which forms the negative pole, and black oxide of copper (Cu. O), the positive pole of the battery. The exciting liquid is simply a solution of caustic potash.

6th. No attention or inspection required, until all the energy of its elements is exhausted.

7th. Convenience of form, and freedom from noxious fumes or chemical deposits. No creeping.

8th. No polarization.

9th. Will not freeze at lowest temperature.

The Edison-Lalande Batteries are made in many sizes and styles, but the "V" cell for portable work and the "S" cell for a permanent installation recommend themselves especially for Phonograph service. Here is a capital "Exhibition" battery, so constructed that it may be moved from place to place with the least possible trouble. It consists of four liquid-tight enameled

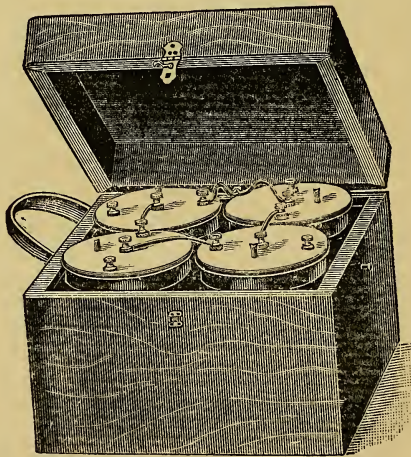

Portable Battery.

steel cells, type "V," capacity 150 ampere-hours, in a polished oak case, with a handy strap for carrying. It measures 13 x 13 x 9½ inches.

This battery will run a Phonograph for 50 hours with a single charge, and as it is absolutely liquid tight, it is just the thing for travelling exhibition work. Weighs 36 pounds empty, and about 50 pounds charged.

For stationary work, the "S" battery has been found to meet all requirements. It consists of four Edison-Lalande cells, type "S" (300 ampere-hours), with battery cords, in a lead-lined polished oak box, size 25½ x 8 x 15 inches.

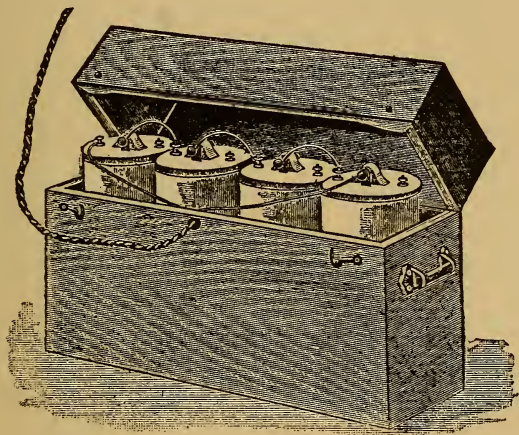

"S" Battery.

This battery will run the Phonograph for 100 hours with a single charge. The matter of weight being a secondary consideration, the cells are larger and are of porcelain instead of enameled steel. Weighs about 90 pounds when charged. With double the capacity of the portable batteries, it costs but 25 per cent. more. For general convenience and efficiency it is equalled by the

storage battery only when the owner of the latter has exceptional facilities for recharging. In general, the primary battery is recommended, as it places the operator in control of the source of his power, thus insuring him a current at all times. This is easily accomplished by his having on hand always a supply of renewals, with which he can recharge his own battery at any time.

Storage Batteries As implied by the name, these batteries store the energy with which they are charged and keep it ready for use at any time. With an electric light or a power station near at hand, at which the batteries may be recharged, they are undoubtedly preferable to any form of primary battery. It will be found convenient to have two or more of the moderate size cells in preference to one large one. These cells are heavy, the plates being of lead, immersed in dilute sulphuric acid. Two smaller cells are not only easier handled than one large one, but by having two or more, a fresh battery may be held always in reserve, thus avoiding the embarrassment and annoyance of an exhausted cell at an inopportune time. The storage battery illustrated weighs thirty-five pounds, and measures 4 x 10 x 14 inches. It will run a Phonograph for 30 continuous hours.

*Instructions
for the
Care & Operation
of
Storage Batteries*

When a new battery is received it should be given a five-hour charge at the normal rate, or at a lower rate for a proportionately greater length of time. Whenever the battery is to be charged, the rubber screw caps should be taken off.

In connecting the charging wires (from a direct current circuit, NOT AN ALTERNATING) to the battery, great care should be taken that the positive wire is connected to the positive pole of the battery, either directly or through the resistance which is usually necessary, and the negative wire to the

negative pole of the battery ; if connected in the reverse direction very serious injury to the battery will ensue.

The height of the solution in the cell should be frequently observed and if there has been such a loss of solution either by evaporation or spilling as to leave the tops of the plates exposed, it should be replaced. If the loss has been occasioned by evaporation,

pure water should be used ; if the loss has been occasioned by spilling, solution should be added ; the solution is dilute sulphuric acid of a specific gravity of 1200° , or 25° Beaume, as shown on the hydrometer, at normal temperature (60°F.). If it is not convenient to procure this solution already mixed and ready for use, it should be prepared by diluting commercial sulphuric acid, or "Oil of Vitriol" as it is more commonly called, with pure water. The acid, as well as the water, must be free from impurities such as iron, arsenic, nitric or hydrochloric acid ; this is ab-

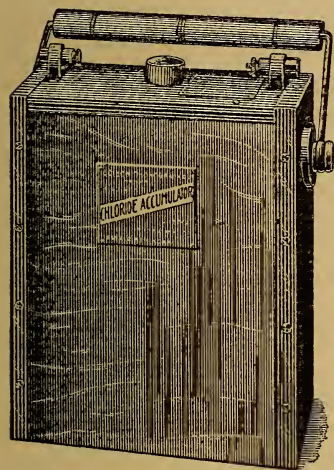

solutely essential. When diluting, the acid must be poured into the water, not the water into the acid ; the proportions of acid (of 1.840 specific gravity) and water are one to five (by volume). The acid must be added to the water slowly and with great caution, on account of the heat generated ; the final density of the solution (1200 specific gravity) must be read when the solution has cooled.

In Phonograph work the battery should not be discharged below 1.9 volts per cell on closed circuit. If a voltmeter is not available, the battery should be considered as discharged when the Phonograph shows the slightest tendency to run slowly

because of lack of power. Never, for any work, discharge below 1.80 volts per cell.

When the battery is being charged, the charge should continue until the voltage on *each* cell reaches $2\frac{1}{2}$ volts with the normal charging current flowing. If a voltmeter is not available the charge should be continued until each cell has been gassing or bubbling freely for at least twenty minutes.

Sometimes, especially if the discharge has been at a very low rate and has extended over several days or more, the charge should be considerably prolonged, as at these rates much more than the normal capacity is taken from the cells.

The rate of charge should never exceed the normal rate of the cell.

Cells should never be allowed to stand discharged, but as soon as exhausted, should be immediately charged up. If, for any reason, the battery is to remain idle for some time, it should first be fully charged and then given a recharge, enough to cause the gassing to be very free, at least once a week.

*Charging from
Lighting
and Railway
Circuit*

It is absolutely necessary that the source of current is from a direct current system. **THE ALTERNATING CURRENT CANNOT BE USED.** Several methods may be employed; the simplest and cheapest, especially if the battery is of moderate capacity (say up to 10 amperes for eight hours), is from the incandescent light circuit, which is almost always available; sometimes, however, it is necessary to draw from either the 500-volt trolley circuit or an arc-light circuit.

In the case of the incandescent light and the trolley circuits, resistance will be necessary to reduce the potential to the proper amount; it is generally most convenient to use lamps for this purpose, the charging current being adjusted by varying the number in circuit.

Charging from Arc-Circuits If an arc-light circuit is the only available charging source the method of connecting in the battery is somewhat different than in the case of the other circuits. Here the battery is put directly in series with an entire circuit of lamps, which are in service either in the building or on the street. In order to insure that this circuit is not broken when the battery is thrown in or out, a peculiarly constructed switch (called a consumer's switch) is required.

The difficulty in the use of this source of current for charging portable batteries lies in the care which must be exercised to avoid injury to persons or property from the high voltage of this class of circuit. This method of charging is recommended only where no other means are available, and should be employed by persons familiar with electrical connections and the handling of high tension wires.

CHAPTER XII.

REPEATING ATTACHMENT.

A SIMPLE and ingenious mechanism by which the SPRING MOTOR, the CONCERT, the "M" and "E" ELECTRIC, and the "M" CONCERT Phonographs may be made to play the same record continuously. Easily regulated. Nickel plated and highly polished throughout.

*Instructions
for
Adjusting* As attached to the Phonograph, the pulley A runs continuously. When the end of a record is reached, the wire B comes into contact with feed nut spring, causing the winch C to engage the clutch D, both C and D being on same shaft as pulley A. The cord is threaded through E, F, G and H, I, J, (the latter being assembled on the speaker arm.) The end of cord is tied into a hole in the speaker arm lift lever. When the winch C and clutch D are engaged, as shown in cut, the winch winds up the cord, first raising the speaker arm lift lever (thus throwing the feed nut out) and then pulls the speaker arm back to starting point, until the feed nut spring strikes the post K. This separates the winch from the clutch and it stops winding up the cord, allowing the speaker arm to drop into position at the beginning of the record, which starts off to repeat.

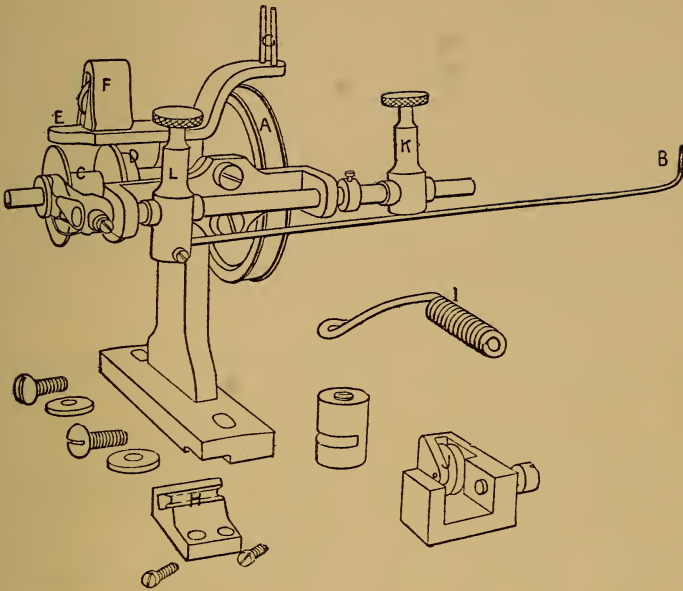

To Adjust With reproducing ball at the beginning of record,
for any see that clutch and winch are disconnected. Move
Length post K against feed nut spring. At end of record,
Record slide post L to right or left as may be necessary, so
 that wire B just touches feed nut spring.

CHAPTER XIII.

BLANKS AND RECORDS.

THE Edison record of to-day is commonly termed "a wax record." There is nothing in its composition that justifies the term, however, as the principal ingredient in the mixture from which the cylinders are moulded, is stearate of soda, a white chemical compound, hard and semi-transparent. These cylinders vary in color, from white to a dark brown, caused by varying conditions in the process of making. This difference in color has no bearing whatever on their quality. They are all of the first grade. In fact, no other than the first grade is known at the Edison Works.

The cylinder as it is first moulded is known as a blank. The Edison blank is chemically pure. It has no successful rival in the market. There is no talking machine company or infringer who does not recognize this fact, and there are no records worth having, that are not made on Edison blanks. Other kinds are gritty, harsh and unserviceable, and little if any cheaper.

As delivered by the factory, blanks do not have surfaces prepared for receiving a record. It is necessary to shave off one or two turns to secure a perfectly true working surface. All Phonographs except the Gem are furnished with a device for doing this. When once trued, the cylinder always remains true. This operation is termed shaving, and is fully treated in the following

Chapter. *Further points are also given in Chapter 3, Part II, on RECORD MAKING.*

*Handling
Cylinder*

The cylinder, which is somewhat brittle, should be handled gently at first, until the operator becomes practised.

Thrust the first and second finger of the right hand into the thick end of the cylinder, and hold it fast by spreading the fingers apart, as shown in the cut. Touching the outside surface of a prepared cylinder, or record as it is called, destroys the attract-

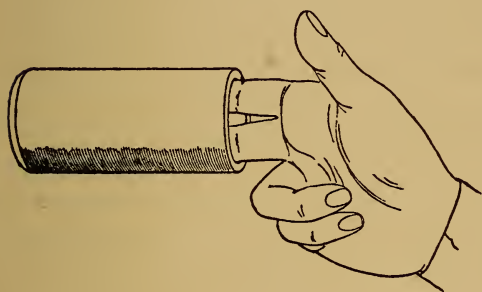

iveness and generally the value of such record. Slip the cylinder, beveled end foremost, upon the tapering mandrel. Push it on the mandrel until it holds firmly, by friction. The inside of the cylinder is also conical, to fit the taper of the mandrel. Not

too tight, or it may crack the record; nor yet again not too loose. If the latter happens, the cylinder revolves on the mandrel, making the record repeat. A warm cylinder should not be put on a cold mandrel, nor a cold cylinder on a warm mandrel, nor should a cylinder be left on the mandrel for any length of time when the machine is not in use. The first and third conditions cause the the compound to contract, resulting in the record binding so tightly that it cannot be removed, and sometimes cracking it. To remove a "frozen" record, put the Phonograph in a very warm room for a short time, which will cause the record to expand. The second condition above noted will make trouble by causing the record to expand and keep slipping on the mandrel. Slot

Phonographs are always equipped with rubber mandrels, thus obviating the difficulties that result from exposure and sudden changes in temperature.

*Cylinders
Should
be Kept*

in boxes or cabinets made for the purpose, which have perpendicular pegs at fixed distances to prevent cylinders from coming in contact with each other. Over these pegs they are placed beveled end down. Use a camel's hair chip brush to remove dust or chips from the surface. Do not attempt to blow them off. Never lay a record down on its side, or handle it other than as described. While it does not absolutely ruin it to touch its surface, still the fingers leave a mark and press in the ever present dust so as to be noticeably apparent in the reproduction.

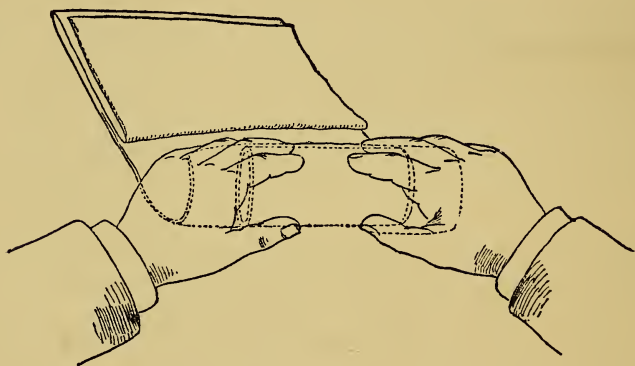

*How to
Wrap
Records*

Split apart the cotton batting and fold back one end so that the glazed outer surface, (which is slightly rough) does not come in contact with the record. The cylinder is then rolled up, with the soft fibre of the cotton toward the record. The record ticket is placed between the cotton and a sheet of paraffine paper; the number and title of the record showing through the paraffine paper. The

ends of the cotton and paper are then tucked inside the cylinder, which, thus wrapped, should fit snugly in the record box.

When wrapped thus carefully, records are not likely to be damaged either when carried or when shipped by freight or express.

*If used
with Care* records will last a long time ; and while they may show a growing harshness as they approach the hundred mark, still they may be used over and over again without appreciable difference, except to a very discerning ear. A cracked record may be repaired if handled deftly. Press the edges of the crack firmly together, using a magnifying glass to determine when the joint is exact. Then heat a knitting needle or table knife, and sear the edges of the crack on the *inside* of the record. The writer has done this with such good luck that the click of the reproducing ball passing over the joint has been hardly noticeable.

Broken records are beyond hope ; they are absolutely of no value.

CHAPTER XIV.

SHAVING.

THE mechanical work has been described in the directions for operating the different Phonographs. Here are some important general points.

The knife should always be allowed to pass over the entire length of the surface of the cylinder, otherwise there will remain a portion of the wax which is thicker than the rest, and if a new adjustment of the knife be made to the right of the end of former cut, it will not touch the surface to the left of it. If adjusted to the left, on reaching that part which was before unshaved the knife will take too deep a chip, and tear instead of cutting the wax.

If the chip chute becomes clogged, it will prevent shaving. Keep the chute clean by raising the speaker arm from the straight edge, moving the carriage to the extreme right, and striking it gently against the back lug of the casting. Under no circumstance jar out the chips by striking the front of the speaker arm on the straight edge.

If the slot in the face of the chip chute (through which the sapphire knife projects and into which the chips or shavings feed) becomes clogged, apply the camel's hair chip brush or a wooden tooth pick. Never touch the cutting edge of the sapphire with a knife or any metal tool.

If desired, the chip chute can be removed entirely by unscrewing its set screw, and the knife will shave without obstruction.

The thinnest possible shaving will leave the smoothest surface. Shave several times in preference to a single deep cut.

New blank cylinders require trueing, as they do not have prepared surfaces, and are likely to be eccentric. In trueing these, *set the knife on the highest part*, if any, of the blank. When once trued, blanks always remain cylindrical.

Never attempt to set the knife while the machine is in motion.

After very little practice the eye and ear of the operator will become accustomed to the sound and appearance of a proper cut, and will readily detect anything wrong. *Other points are given in Chapter 3, Part III.* THE SECRET OF MAKING PHONOGRAPH RECORDS.

CHAPTER XV.

DICTATING.

A PERSON desiring to dictate letters, essays, or statements, simply places the cylinder on the mandrel of the instrument, and dictates at leisure. Should the dictator, at any time while dictating, desire to pause, all that is necessary is to raise the lift lever on the speaker arm and cease talking. The Phonograph gives these special advantages to the person dictating; it is a silent and patient amanuensis, and is always ready to record what is said; it will take down exactly what is spoken to it, word for word, and the only care required is that the person talking to the machine articulates distinctly.

The Edison Standard Speaker, (See Chapter 16, Part II) combining both recorder and reproducer, is generally used on commercial Phonographs.

In dictating, the correspondent has frequent occasion to pause, and in many cases loses the thread of his discourse. To stop abruptly in the course of a dictation, it is only necessary to raise the lift lever without stopping the machine. In resuming, should the last few phrases be forgotten, lower the lift lever, and, raising the speaker lever, listen with the speaking tube. The action of the speaker lever throws the reproducer into the track some five or six threads back of where the recorder stopped. After listen-

ing to the last few words, lower the speaker lever (thus bringing the recorder into position) and continue dictating (without stopping the machine).

To avoid errors, the names of persons and places should always be spelled out, unless the operator is familiar with them. *For further particulars see Chapter 5, Part III.* THE PHONOGRAPH AS AN AID TO THE ARTS OF STENOGRAPHY AND TYPEWRITING.

The speed of the main shaft for dictating should not be less than seventy or eighty revolutions per minute, at which speed it will take about four and one-half to five minutes to cover the entire surface. Musical records should not be recorded at less than one hundred and twenty-five revolutions per minute. Until the eye becomes practiced the number of revolutions of the shaft can be determined by counting the revolutions of the set screw in pulley.

Should the end of cylinder be reached before a letter is ended, it is only necessary to say "Continued," and finish upon another cylinder.

The advantages of the Phonograph for commercial work, may be summed up pithily and tersely in the following ten points :

1. SPEED. You may dictate as rapidly as you please, and are never asked to repeat.
2. CONVENIENCE. You dictate alone at any hour that may suit you.
3. SAVING OF OPERATOR'S TIME. During the dictation, instead of receiving notes, the operator can be employed upon other work. Aside from this, the operator can make much better speed in typewriting from the Phonograph, than from shorthand notes.
4. ACCURACY. The Phonograph can only repeat what has been said to it.

5. INDEPENDENCE. It is easy to replace a typewriter operator, but a good stenographer is hard to find.

6. ECONOMY. The saving in your own and in your operator's time, will more than pay for a Phonograph in less than a year.

7. TIRELESSNESS. The Phonograph is always ready for work.

8. SIMPLICITY. The method is simple. No time need be lost in learning it, by either dictator or transcriber. You can commence work at once.

9. CONTROL. The Phonograph is always perfectly under the control of both dictator and transcriber. The former cannot dictate too fast for the latter.

10. PROGRESSIVENESS. The largest and most progressive business houses in the country are using Phonographs, and enthusiastically indorse them.

For further details concerning the use of the Phonograph in business, see Chapter 5, Part III, THE PHONOGRAPH AS AN AID TO THE ARTS OF STENOGRAPHY AND TYPEWRITING.

CHAPTER XVI.

SPEAKERS.

The Edison Automatic Reproducer As its name implies, is made for reproducing purposes only, and is of the greatest value to every user. For reproducing only, the Automatic Reproducer is recommended as being superior to the Standard Speaker. For the information of those not acquainted with either, a brief description follows. It has no recording sapphire nor can one be attached to it. It does away with the use of the speaker adjusting screw, as it is so constructed that it always tracks the thread of the record, overcoming the expansion and contraction of the wax cylinder in different temperatures. Thus, when the "track" is once found, the reproducing ball remains properly adjusted, and the reproduction holds clear and firm throughout. On account of always being in the track, it sounds much louder than the Standard Speaker, which may get out of track, thus requiring adjustment by use of adjusting screw.

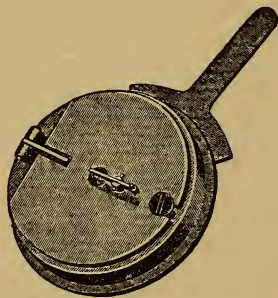

The Edison Standard Speaker

Is a combination recording and reproducing device, being equipped with two sapphires, one for recording and the other for reproducing. It was designed for recording and instant reproduction for dictation

purposes, thus obviating the necessity of change of speakers. In combining these qualities, it was necessary to design and construct it with rigid weights. Owing to its rigid character, and the unequal expansion and contraction of the wax cylinder, the reproducer sometimes loses the track of the record, and requires to be adjusted by the use of the speaker adjusting screw.

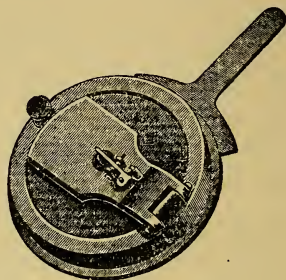

The Edison Recorder

As its name indicates, is especially adapted for recording purposes only. It is not constructed so rigidly as the Standard Speaker, and consequently

adjusts itself automatically, making an even and unvarying cut on the surface of the blank. It is furnished with a recording sapphire only, of the highest quality and most delicate adjustment. The adept at record making will find in this attachment the finest recording equipment that can be produced. It is used by all the leading makers of high-priced Original Records.

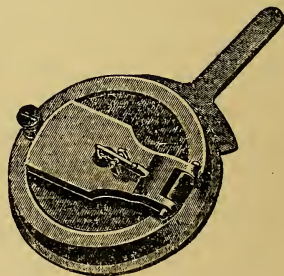

The Proper Diaphragms To Use Complete and detailed instructions as to what diaphragms are the best for recording different volumes and qualities of sound, are given in Chapter 3, Part III, THE SECRET OF MAKING PHONOGRAPH RECORDS.

*How to
Repair or
Adjust
Speakers*

All that is necessary is the "know how" and a small bottle of stratena. Unscrew the speaker-clamp-ring A, and remove the tube-plate B. On top of the glass diaphragm you will find a thin rubber ring GG (called a gasket). If this gasket has become hard, do not use it again. Take it out. Then remove the glass diaphragm. On the under side of the diaphragm DD is another gasket GG. If this has not become hard it can be used again, otherwise throw it away.

See that a rubber gasket is always placed under the diaphragm. Now put the diaphragm into place on top of the gasket, being careful that it does not touch the side of the cup. This is important. Now place another gasket on top of the glass, adjust tube-

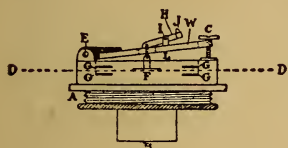

Fig. 1.

Cross Section View.

plate in position and tighten the speaker-clamp-ring, which should not be screwed in too tight or yet left too loose. If too tight the diaphragm ceases to be sensitive. If too loose the record will whistle or blast. There is a happy medium which you must discover for yourself.

Unscrew the speaker-weight-limiting-screw C allowing the speaker-weight W to swing freely on the hinge pin E. Do not allow the weight to touch the glass. If this is done it may crack the glass.

The cross-head F (a small flat metal disc) hangs from a tiny link L, from the reproducer arm H. If the glass diaphragm has been broken, the cross-head should be scraped so that no cement or bits of broken glass remain on it. It should also be washed with a clean cloth so that no dirt or oil remains on it. Benzine will do this thoroughly.

If you are changing diaphragms (substituting either a thinner or thicker glass for the one in use) the stratena which cements the cross-head to the glass may be melted by applying heat to it.

The safest way is to heat the head of a nail fairly hot and press it gradually against the glass under the cross-head. It may crack the glass but it is the surest way of detaching the cross-head. The new glass to be substituted must also be cleaned thoroughly (preferably with benzine) as any oil or dirt on either the diaphragm or the cross-head makes it difficult to make a good joint with the cement.

Dip the end of a match into the stratenia and drop a very small drop in the centre of the glass diaphragm. Lower the speaker-weight *very very* slowly to the glass and then with the aid of a pin or some sharp pointed instrument, place the cross-head in position; pressing it firmly. A small wedge of paper under the sapphire point will serve this purpose very nicely. Now place the weight-limiting-screw in position, then turn the speaker so that it rests on the tube-plate as shown in Fig. 1, and allow the stratenia to dry for at least an hour.

Fig. 2.

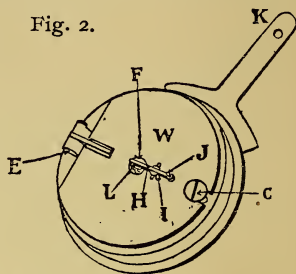

INDEX OF PARTS.

A—Speaker-Clamp-Ring.
 B—Tube-Plate.
 C—Limiting-Screw.
 D—Diaphragm.
 E—Hinge Pin.
 F—Cross-Head.
 G—Rubber Gasket.

H—Reproducer Arm.
 I—Reproducing Arm Pin.
 J—Sapphire.
 K—Speaker Lever.
 L—Link.
 W—Speaker Weight.

Great care should be taken not to use the speaker until the stratenia has become thoroughly dry. These same instructions apply in the adjustment of the Edison Automatic Reproducer, The Edison Standard Speaker, and The Edison Recorder.

CHAPTER XVII.

A WORD ABOUT BELTS.

THE slipping of the drive belt on the main shaft pulley is due to the following conditions :

AN OILY BELT is the most frequent cause. When oiling a Phonograph, absolutely no oil should be put on the surface of the pulley or on the belt. When this happens it not only makes the belt slip but softens the leather, thus causing it to stretch very easily.

A LOOSE BELT.—In spite of great care used in selecting material, a belt is sometimes cut from a stretchy part of the leather, or, again (as above noted), oil will cause the best belt to stretch very quickly. With ordinary care a belt will last a year without the need of renewal. A belt should not be renewed or shortened under the impression that it is too loose, until the idler pulley (which is placed on every Phonograph for the very purpose of taking up the slack in a belt) touches, or nearly touches, the drive wheel inside the mechanism.

TO SHORTEN A BELT.—Dampen it at the point where it is already joined. When the ends separate, dry thoroughly. Apply stratena on the parts to be joined, overlap a quarter to a half an inch as may be necessary and press firmly together for an hour or two. If the belt is oily it will be impossible to make the cement stick. Buy a new one.

PART THIRD

THE OPENEER PAPERS

CHAPTER I.

WHAT MR. OPENEER HEARD.

LAST Christmas my wife and I were invited to a house party at Larchmont, New York. The gray afternoon was deepening into dim dusk as the sleigh left the little station, and the cold was intense. Our fifteen minutes' ride to the home of our host chilled us through and through, and as we fumbled with wraps and gloves in the silent hall of the house, our feelings were divided between personal discomfort and wonderment that no one was there to greet us. Suddenly there piped up a thin little voice seeming to come from nowhere. It grew louder and stronger, and we heard "Merry Christmas, merry, merry Christmas. Welcome, Mr. Openeer; we are glad to see you. Welcome, Mrs. Openeer; how is the baby? How did you leave Ponjo?" (Ponjo is our dog). We looked around bewildered. The voice continued: "Take off your wraps; lay them on the table. James will see them safely laid



away." Astonishment gave way to curiosity, and we drew aside a curtain and found the cheery speaker to be—a Phonograph. Then through a half-open door we heard whisperings and merry laughter as the uncanny little machine went on to sing for us a Christmas glee. Before it was finished the children of the house came running in laughing, followed by our hostess and the other guests; and we saw and

felt heartily the double welcome that had been prepared for us. The surprise had all been planned. Our host had talked and sung this Christmas greeting *into* the Phonograph the night before, making a "record" with which the jolly little machine could greet each guest as he arrived. We saw it all when Jack Halsey and his sister came, about five minutes later. "Here comes



Jack," called one of the children from the porte cochère window; and hastily adjusting the wax cylinder ticketed "Halsey," we waited in the dining-room and den with half-open doors as they entered. "Hello, Jack," said the Phonograph behind the curtain, "How d'ye do, Clare? Glad to see you. Come in and stay a while." They stopped and stared around, bewildered, just as we had done. "Take off your things.

Merry Christmas." And then, without stopping, the wonderful toy began to play the banjo. Then, we, all of us burst in upon the astonished pair, and welcomed them amid shouts of laughter.

The thing entertained us all next day. When we tired of hearing our own voices fired back at us, we played the piano for it. Then we made a quartette of banjoists: then our host played the cornet; then we sang—solos, duets and choruses; and the "bally little mocker," as Algy Dunraven called it, gave us every time as good as we gave it. Why, it was perfectly wonderful!



Then we were entertained with boughten records. Selections by famous bands and orchestras, operatic, military marches and dance music, all in perfect time, and loud and clear. Songs by famous singers, speeches by famous men, funny talks and dialect records. Why, we spent a delightful time. Our host told us confidentially that had he engaged the artists, performers and bands to appear in person, a thousand dollars would



have been a reasonable price for the entertainment that was provided for less than a tenth of that sum. And, best of all, he could repeat the whole programme the very next night if he wanted to. And we believed every word, because we heard it all ourselves.

I have since bought a Phonograph for myself ; and have been repaid a hundred times for the investment, by the fun and entertainment I've got out of it. My advice to my friends is, "Go and do likewise."

My wife called on our next door neighbor the other day to sympathize with her over the loss of their eight-year-old boy. They had bought a Phonograph, by the way, immediately on hearing ours. Well, the conversation naturally was about the dear little fellow who had just crossed over the Dark River. And she could not stop talking to my wife about his pretty eyes and curly hair hair and laughing voice.

"It's one of the greatest consolations that I have these," she said, going to her record cabinet ; and carefully taking from it three of the wax cylinders, she put one on the machine. The next moment it was as if Harry was in the room. First came his merry laugh, then an aside. "Dear mamma, do keep quiet while I speak my piece." Then came a steady little voice, clear and strong :



Then came a steady little

"A tiny little seed am I,
 In the mold,
 Hidden from the great blue sky
 And the cold.
 I throw my little rootlets out
 And feel around.
 There! I almost turned about
 In the ground.
 Did I hear a bluebird sing?
 Can it be?
 If I did it must be spring.
 I'll go and see."

Then there sounded a clapping of hands and bits of conversation. His mother sat there with tears in her eyes, but with a joyous look on her face. "My precious first born," was all she said. And one of the first things my wife did when she came home that afternoon was to take our poor little youngster and make half a dozen records of his chatter and baby-talk right away. I fancy him listening to those "talks" twenty years from now! But should he be taken from us in the meanwhile, I know I'd hold them as my most highly-prized possession.

I heard of a novel use for a Phonograph the other day. Teaching languages—what do you think of that? My wife told me about it. Somewhere in her afternoon calls she saw the whole thing. There was a Phonograph grinding off a French cylinder that had been specially prepared by the visiting teacher the day before: "J'ai, tu as, il a, elle a, nous avons, vous avez, ils ont, elles ont," over and over and over. Then, "Avez vous le pain, avez vous le pain," and so on through a long list of words and phrases. Parrot like, perhaps, but *there* was the pronunciation and accent. Capital! The children *couldn't* get away from it. Then came a German record, "Der die das. des der des, dem der dem," and so on. The broad a, the short i, the funny ö in König, the elusive and difficult umlaut. "Haben sie das brod. Wo ist mein Hut? Ich liebe dich," and little poems and couplets.



"Man sieht sich, lernt sich kennen,
Liebt sich, muss sich trennen."

Rather advanced for children, this; but I suppose their teacher was in love and felt a bit sentimental just then.

"Ein verhungert Huhnchen fand
Einen feinen Diamant
Und verscharrt ihn in den Sand."



This was better. But the whole idea struck me very forcibly. The difficult pronunciation was there—always on tap—over and over, sinking deep into the minds and memories of the little youngsters, and especially so because it was a novelty. Ah! that's the point. New ideas appeal to children just as much as to "grown ups."

I look forward to the day when a great many other things besides the languages will be taught through the aid of this marvelous little talking-machine.

While the field of the Phonograph is a wonderfully large one, yet it reaches its limits, like everything else in this world for that matter. The recent attempt of the Sophomores of Ithaca to give their orations by talking machines was very laughable. The Professors found out what was in the wind and promptly vetoed it, but not before several rehearsals had been held to demonstrate its feasibility. The Freshies found it out, too, and invaded one of their trials with pitchers of



water, which they poured into the Phonograph horns with dire results. The practicability of the scheme is assured, however, and some day we may hear of a commencement conducted entirely by machine talkers.

This reminds me of an occurrence that happened several years ago, when the Phonograph was first brought out. A very advanced Dominie at Hasbrouck Heights, N. J., conceived the idea of a novel Sunday evening service; so he prepared his sermon—a short one—and several hymns and scripture readings



the day before on a number of cylinders; and he actually held the meeting, "as advertised." The affair created quite a sensation indeed. Inside of a month the Rev. Mr. Dominie was preaching in a church out West,—*preaching*, mind you,—no more Phonograph for him. Well, it simply proves the truth of the saying, "Everything in its proper place."

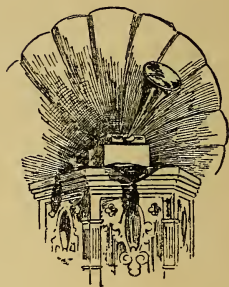

The Phonograph for dictation in business offices has long been a success. Instead of of talking to a giddy and unreliable young lady stenographer (not *all* of them, I assure you, O ye wives of busy husbands, but sometimes—quite often), the letter is *talked*, just the same, into the specially prepared cylinders, until a dozen or so are ready for the typewriter clerk. Then he is called from his work and transcribes the records at leisure. See? He

is working all the time while you are dictating. With hearing-tubes in his ears, he puts each cylinder on another Phonograph in front of his typewriter, and pegs right along. There's no loss of time. He is always working and he's much cheaper than a "stenographer and typewriter." The experiment has been tried also, with some success, of sending the record, just exactly as you've talked into it, by mail or express, directly to your correspondent.



It has remained for Mrs. Openeer to discover the most novel use for the Phonograph as an entertainer. She gave a "Voice Guessing party" last week, and we had all kinds of fun and

jollity over the funny guesses. It's somewhat similar to a "Perfume Party." You know how that's done. Twelve or fifteen little vials, all alike as to appearance, are filled with different perfumes. It adds to the perplexity of the guessers to include



vinegar, alcohol, benzine, turpentine, chloroform or kerosene. Then the contestants smell and guess, and the winner of the prize is the one who has the longest correct list. My wife conducted her party on a similar plan. Each guest made a three minutes' talk into a Phonograph in separate rooms (we borrowed two other machines for the evening), and after every one had talked or sung, either in

natural voice or disguised, we played the records before all the assembled guests. Each was provided with paper and pencil. The scheme was immense. You can imagine the hilarity that greeted the wild guesses when the results were declared. A surprising number of the voices were guessed correctly, however, and the entertainment was voted by all to be a very happy success. I tell you, my friends, it takes a Phonograph every time to be a fun-maker.



I represent a chemical syndicate. It's a far cry from sulphuric acid and by-products to Phonographs, I know, but you will see the connection presently. There's a town I strike when I'm on the road where there is a most unique collection of stories: unpublished unbound, yet indestructible, and most carefully preserved. The genius who is making the collection does business





in Louisville, what street I won't say, and whenever a drummer shoots a good story at him he says, "Hold up—come here," and then and there, on the spot, he embalms Mr. Drummer in wax; and like a fly in amber, his funny tale is preserved for all time. I've sat by the hour listening to stories; and *such* stories. Cylinder after cylinder, every one different. Every now and then I'd recognize a fellow knight of the road; some I hadn't met for years, some dead. I do not hesitate to say that Mr. Blank's collection of stories hasn't an equal in the whole world. Some of the mildest of them, revised and expurgated, are often heard in vaudeville; but for the most part, the "Louisville records" are to be heard only by the favored few who are in the ring. I have lately heard of other collections, but none to equal that of the pioneer, Mr. Blank.

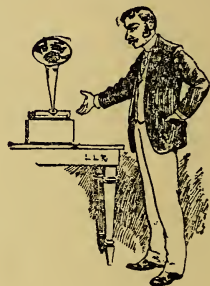

I told my wife about Blank's collection the last time I made home after a three week's flier, and gave her a sketch—very sketchy, indeed—of some of the yarns. She said, "Capital idea!" and before I knew what she was about she started what is now known to my friends as "Openeer's Voice Album." As a novelty, it proves very interesting to visitors, and bids fair to be as popular as the old-fashioned autograph collections, and, in fact, supplements that and the photograph album most beautifully. We limit our friends to a half-minute's talk, first announcing the name and

following with a funny short talk, or a touching sentiment, or a bit of poetry; and really, we have a delightful way of entertaining our guests, as any one who has made Phonograph records for friends well knows.

The hot and bloody work before Santiago, in Cuba, has made one of my wife's Voice Album records of inestimable value. Young Smith, of the 71st New York, was my cousin, and was among the first to try the effect of his voice on a wax cylinder. His name comes out loud and clear, and then these words:

"Of all the fish in sea or lake
The bloomin' codfish takes the cake."



Its funny, but it's sad too; for poor Smith was shot through the lungs with a Mauser bullet and died seven days afterward. When his father learned of the record we had of his voice, he bought the finest, most expensive Phonograph to be had; and we gave him our cylinder, taking several copies or duplicates of it for ourselves and his friends. This is easily done, you know, by connecting the "speaker" from the Phonograph that is playing the original to the "recorder" of another machine, on which is a smooth

blank. Of course, this copy is a little indistinct—all duplicates are. The original Edison records such as you buy are always the best. But the copies we



made were plain enough for us to distinguish Bert's voice, and we are proud of it, I can tell you, not only for the satisfaction of having a *hero* record in our collection, but also that we were able to be of service to his father; for the old gentleman holds that cylinder as one of his choicest possessions on earth.

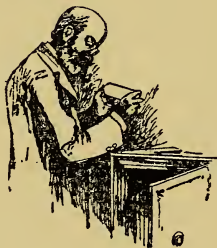

CHAPTER II.

HOW WE GAVE A PHONOGRAPH PARTY.

IT was Charlotte's plan. The idea struck her suddenly (they always do come to her that way) during an evening we were spending over at the Openeer's. Young Mrs. Openeer had asked us to dine with them and play whist ; but after dinner Mr. Openeer started one of his Phonographs so that we could hear an opera we had been talking about, and cards were entirely forgotten. It was delightful. They had lots of the wax records—almost a complete score of the opera in question. The talk naturally turned on how it was all done, for it seemed perfectly wonderful. So he showed us all about it, and that's how Charlotte's inspiration came.

“ I have it, I have it ” she whispered excitedly the moment we left the house, and she almost pushed me down the steps in her eagerness. “ We will give a Phonograph Party, and it will be the newest and most delightful thing out,” and she straightway unfolded the whole scheme as we crossed the street to our house. By the time we had climbed up to our room the schedule was complete. I must say that Charlotte is a quick and ready thinker. Her plan was fine. You see she teaches mathematics in the high school, while I have only a kindergarten class. She thought the idea and I completed the practical arrangements ; and between us



we planned an entertainment which I am sure will be long remembered by our friends as a very happy evening.

We sent out our invitations the very next day, for Wednesday evening of the following week. To Beverly Dunlap's we added a line "Bring your cornet." To Alice Blank's "Please bring your banjo. Will Hamilton's also had a "banjo" postscript, and Nat Browton's a "clarinet" item. Charlotte had a

violin and I a guitar, which, with the piano (fortunately an upright), would give a variety of instrumental music for the occasion. In each of the other notes, we wrote the mystifying words "Please bring your voice."

To Mr. and Mrs. Openeer's invitation Charlotte insisted on adding (as a matter of form only she explained to me), "Please bring your Phonographs;" for we had already enlisted their cooperation, and Mr. Openeer had entered into our plan with enthusiasm. He loaned us not one, but two Phonographs "for convenience sake," said he, "one for recording and one for reproducing. Saves the bother of changing speakers and horns." He also insisted on furnishing us with a plentiful supply of smooth wax cylinders or blanks as they are called; at the same time offering us his services as an expert should we need him.

The next few days saw us busy at every spare moment. First we tried and experimented in every possible way with the Phonograph, making record after record, until we found out just how to do it. It's wonderfully simple if you only know how



(like everything else in this world for that matter). Mr. Openeer offered to teach us, but we wanted to find out all by ourselves; and we did very nicely by following the printed instructions which he furnished us. Then we had refreshments to prepare. Charlotte gave way to my ideas in this matter, and my kindergarten training suggested that we get some jelly glasses that were just the right size, two and a half inches across and four inches deep. Into these, we packed

our ice cream after we had made it, so that each guest should have a "frozen record" just like that great fib of Baron Munchausen's. We also made ginger snaps in the shape of a horn, by fashioning a cake cutter out of a strip of tin. All our plans matured beautifully, except that Charlotte scorched two whole pans of ginger snaps, and let some salt get into the ice cream tins; Charlotte was never good at those things.

Every one of our guests came on Wednesday evening; every one of them as curious as an original Eve (or Adam) and every one of them delighted on learning what was in prospect. We commenced right away with the cornet. It makes a fine loud record. and we wanted to start off auspiciously. We had placed our Recording Phonograph high up on a small table, so that the horn was about on a level with Mr. Dunlap's head, as he stood ready to play. The shape of the horn, too, makes some little difference.



Mr. Openeer loaned us his recording horn for our party. It was fully two feet long and shaped like a cone. It had no flare or bell on the end, which was about 6 or 7 inches across. Our equipment was really quite perfect. The second Phonograph stood on one end of the large table and was fitted with a reproducing diaphragm or speaker as they call it. It also had a small fourteen-inch bell shaped horn, which shape seems to spread the sound better than the other. I attended to the machine, put on a new blank and started it, while Charlotte started each performer. At the close of each record taking, I stopped the machine, took off the record and put it on the reproducing Phonograph, and we all heard what had just been played into the other machine, reproduced with startling and marvelous exactness.



I will say right here that a single Phonograph with two speakers and a bell shaped horn would have been all that was absolutely necessary. The only advantage of having two Phonographs was that it saved the delay (a very small matter) of changing the recording speaker for the reproducer after each record was made.

As directed by Charlotte, Mr. Dunlap stood about five feet away, and played directly into the horn. He gave a short aria from "Maritana," playing it with considerable volume and with even, well sustained notes, with but little attempt at expression. He used only half his record in a minute and a half, so Charlotte whispered "Do you know any bugle calls?" (Dunlap was in camp at Jacksonville all through the war). His laughing answer "Do I know any bugle calls by heart? well, rather!" made us all laugh too. It was wonderful the way he made his cornet fairly talk.

“ I can't get 'em up
 I can't get 'em up
 I can't get 'em up
 In the morning.”

His attempt ended in a storm of applause, which was repeated a few minutes later when I changed his record to the other Phonograph and reproduced it. First came the aria, loud and clear and distinct. Then a pause of a few seconds. Then a big manly voice said “ Do I know any bugle calls by heart? Well, rather.” How we all shouted! It did sound so funny. Then came his bugle call and a faint clapping of hands and then our real applause. Our first record was a success!

Then Nat Browton played his clarinet; and the reproduction was so perfect that we could actually hear his breathing. Those quick little gasps for breath that I for one had never particularly noticed, until the reproduction of the record called it to my attention. He played directly into the horn, and as close to it as he could.



Then we had several vocal solos. Each singer stood close to the horn, with the face almost within the opening. Charlotte cautioned them all to sing rather loud and be particularly careful to draw back the head while taking any high notes. Our bass and baritone artists made highly successful records. Our tenor sang “ The Holy City ” most beautifully, but his voice lacked that peculiar quality necessary for Phonograph record making. The tones of his voice were like the invisible rays of the spectrum beyond the violet; it seemed impossible to record them. Charlotte discoursed learnedly about the number of vibrations per

second caused by his high C—about a thousand I think she said.

Mr. Openeer lessened his discomfiture by remarking that a Phonograph tenor was an exceedingly rare phenomenon. "As rare as a Phonograph soprano" he added bowing to Mrs. Openeer who was our next performer, "and although my wife has a beautiful voice I have never yet taken a really good record of it."

We made a passably fair record of Mrs. Openeer's fine soprano voice by draping the opening of the horn with mosquito netting; but it wasn't real good and we had to put it in the same class with the tenor's; and also with Charlotte's violin record, which came next on the programme. The amateur

will do well to avoid the sorrow that is almost inevitable in attempting to make a record of a high tenor, a soprano or a violin.

The most effective records we made during the entire evening were two chorus records. All stood close together in a bunch about three feet from the horn and sang "Marching through Georgia," and it came out fine. Our success led us to try another, "Onward Christian Soldiers," and it was every bit as good. The

piano accompaniments of all our records were very good indeed. In every case the piano stood about three feet distant, with its open back towards the Phonograph. A square or a grand piano is not so well adapted for this accompaniment work, although a solo may be recorded very nicely by bringing the horn close up to the raised cover of the instrument.



We now removed our Recording Phonograph from its lofty perch, to accommodate our banjoists and also those of our guests who were to make talking records, and preferred to sit rather than stand. The banjo should be played as close to the horn as is possible. We made several capital records, so loud and natural as to tone quality that I would defy anyone listening with eyes shut or in the next room to tell the difference.

The talking records were mostly all good too. The performers were cautioned to speak very distinctly, sounding the S's and soft C's with particular emphasis. Some of them caused lots of merriment when they were reproduced, owing to the funny and irrelevant side remarks of the speakers; most of whom had never talked into a Phonograph, and seemed to forget that the machine would catch and repeat all that was said.

Last of all came the ginger-snap horns and the "frozen records." The tenor declared that these were the best of



all. He may have been perfectly honest (for they were real good) or it may have been gross flattery; or yet again his failure may have made him a little jealous of the others. But, somehow, I didn't exactly like his remark. I think on the whole, while perfectly polite and courteous to Charlotte and me, his hostesses, what he said simply proved the proverb, "the way to a man's heart is through his stomach;" for the rest of us agreed, not even counting in our "frozen records," that our Phonograph Party had been a grand success.

CHAPTER III.

THE SECRET OF MAKING PHONOGRAPH RECORDS.

THE secret of making Phonograph records is summed up briefly as follows :—experience and knowledge of the Art.

The two go together. One is useless without the other. What I know about it has been the result of a great deal of experimenting (such as you must do) combined with many useful hints and pointers and suggestions gathered from practical Phonograph men (which I propose to tell you). You will then know all that I know, which, after all, isn't so much. What I don't know about it would fill books ; a negative way of expressing my modesty, perhaps ; but, as in photography, the negative prints the positive, so will my negative assertion serve to bring out more clearly the details of that greatest of Phonographic problems—the making of a perfect record.

Let's talk about the Recorder to begin with, for that is the heart of the whole matter. Your recorder must be perfectly adjusted and adapted for the particular kind of record you are taking. This is largely a matter of judgment and experience. Certain musical instruments and certain qualities of voice, will record with a squeak or a blast when a glass diaphragm of a certain thinness is used, and yet will record perfectly if a thicker or thinner diaphragm is substituted. Recorders are usually

equipped with a No. 7 to a No. 8 diaphragm; that is to say the glass is from 7-1000 to 8-1000 of an inch thick. The rubber washers between which the diaphragm rests, may have become hardened. Rubber does, you know, get either hard or sticky in time. This interferes with the free vibration of the diaphragm, and consequently affects the clearness of the record, and new washers should be substituted. In changing washers or diaphragms the metal clamp-ring should not be screwed in too tight, nor yet left too loose. If too tight, the diaphragm ceases to be sensitive. If too loose, the record will whistle or blast. There is a happy medium which you must discover for yourself. See also that the tiny metal arm is cemented firmly to the center of the glass; if not, you will get a dull, rasping quality of sound that is very unnatural. The sapphire recording point must have a sharp even surface, that it may readily engrave the surface of the cylinder. Great care should be taken in handling or laying down the recorder, that the sapphire stylus does not come into contact with a hard surface of any kind. A chipped stylus is a frequent cause of poor records. I mention these points in detail as it is of the greatest importance that you become familiar with them. You've got to know the tools you work with; and especially the glass diaphragm, which is the most delicate and sensitive part.

Now, as to the various diaphragms to use. In making vocal records, it depends entirely on the strength of voice of the singer; varying all the way from an 8 down to a 6 glass. The thinner the diaphragm, the more sensitive it is. Take, for instance, a singer with a good loud voice. Use an 8 glass. Should the record not come out strong and if it has no blasty defects, try a $7\frac{1}{2}$, then a 7, or even a $6\frac{1}{2}$. The moment the record blasts, your diaphragm is too thin and over-sensitive for the voice. "If at first you don't succeed, try, try again!" It is a very apt motto to adopt in record making.

For a cornet, use an 8 or a 7 glass. Use an 8 or a $7\frac{1}{2}$ for a band record or an orchestra record. For a clarinet, try a 7 or

a 6. For a piccolo a 6. For a banjo or xylophone record a 6 or a 5. For a violin, a $6\frac{1}{2}$ down to a 5. For talking records, use a 6 glass.

Upon the shape of your horn, also, depends in a great measure your success as a record maker. The horn should be pointed on the level with the head of the performer. In other words, the Phonograph itself should be about on a level with the head. The best results for talking records are obtained by using the mohair speaking tube. If the peculiar quality of a speaker's voice should make the record sound muffled, try the bell-shaped 14-inch brass horn with which most Phonographs are equipped; or the 26-inch japanned tin horn may also be used with good effect. It all depends on the quality and loudness of the speaker's voice. The 26-inch japanned tin horn is also a good shape to use for banjo, violin, xylophone, cornet, band and orchestra records; although a regular special recording horn would be better. These special horns are made of block tin, long and narrow in shape, being from 20 to 26 inches long and not more than 6 inches across the end, perfectly conical in shape, with no flare or bell on the end. They are the very best shape for all vocal records, and also for the piccolo or clarinet. While good records may be made with the regular shape 26-inch japanned tin horn, it is best not to take any chances. In making records, strict attention must be paid to the smallest details. The veriest trifle will sometimes spoil the best attempt.

Next, the wax cylinder should be perfectly smooth and true. Much depends on the absolute smoothness of the wax blanks. If you do your own shaving, run the machine at the highest possible speed; and do not cut too deep. If you do, it causes the wax to chip, leaving a broken crackled surface on which a good record cannot be made. Shave several times in preference to one deep cut. The Edison blanks you can buy already shaved are superior to any possible work you can turn out yourself, as they are shaved by a special machine running at a very high rate of

speed and are absolutely accurate. Be very careful in handling the shaved blank, that no finger marks are left on its surface. Should there be any residue of the shaving operation left on it, take the cotton in which the blank is wrapped, and tear open one end, picking out the frayed edge to make a soft brush, and brush the blank gently, with a downward motion. Don't breathe or blow on the surface to remove the wax dust. Better still for this purpose is a soft wide camel's hair brush.

Lastly, see that your Phonograph itself is in perfect running order, well oiled and free from dust. This is an essential to perfect work with any piece of machinery, and the Phonograph is no exception in this respect. Any undue friction will make a grind or rumble, and will seriously mar your attempt by making itself heard in the record you are making. If the machine makes discordant records, or false tones, it may be that the belt is loose, thus causing the main shaft to slip. If your Phonograph is an electric machine, the governor contact may be dirty. Care should be taken if you use a machine of the spring motor type, that the mechanism is always fully wound. A record made while the machine is running down will reproduce with a varying pitch, thus destroying all harmony. The proper speed for recording is about 125 revolutions per minute. This is easily ascertained by watching the screw on the pulley, and counting and timing the turns.

As to the room in which you take your records, it might be well to have no curtains or other soft hangings. In a perfectly bare room, with no carpets or furniture or draperies, a record will have a certain ring to it, a peculiar resonant quality of sound that some prefer. One objection to stripping a room in this manner, is that there is a greater likelihood of your records blasting. On the other hand a "seasoned," room with just enough hangings to break up any echoes, makes a richer, more mellow tone quality. This is largely a matter of individual taste and judgment; and can only be determined by experimenting and watching results very carefully. All these are points that may seem to be un-

important, but if you are after success, you cannot afford to omit the smallest detail that might help you to secure the most satisfactory results.

And now for the record. If a vocal solo is to be recorded, the singer should stand immediately in front of the recording horn, not more than three or four inches from the opening, and should sing directly into it. The articulation should be very distinct. Avoid singing with too much expression. That voice will record best that has an even quality throughout the entire register. Some voices are full and rich and mellow in the lower notes, and thin or weak in the upper register. In all cases, choose the songs that are best suited for the singer's range of voice. When a high note is sung, the singer should draw back the head, away from the horn, so as to equalize the vibrations. Either do this, or repress the voice so that the tones are covered. Should the singer make a very strong and loud record, with a blasty imperfection in only one or two spots, keep the same diaphragm, and try to remedy by drawing away from the horn at the high notes that blast; in other words, correct the blasting, if possible, by covering the objectionable tones rather than by substituting a thicker diaphragm, which might make the whole record weak. In general, the tones that cause the defect of blasting are open tones, the long "i" sound, the "o" as in "love" the word "heart." These tones occurring on high notes, almost invariably cause trouble, even with experts in the art. Scientists estimate that there are over a thousand sound waves per second in the high C of a tenor. To record high notes accurately and naturally is very difficult, on account of the exceeding rapidity of the vibration. A soprano high C being an octave higher is still more difficult to record. In fact, women's voices are the least satisfactory records for an amateur to attempt, on account of the great amplitude as well as the rapidity of the vibrations.

In making talking records, speak naturally, but with energy. Do not force the voice too much. Articulate plainly, sounding

the s's and c's with particular distinctness. In using the speaking tube, the lips should just about touch the mouth piece. With the 14-inch horn, or the 26-inch japanned tin horn, the speaker should be from two to four inches away. Experiments will prove the proper position for each speaker. In making tests, announce upon the record each change you try, so that the effect of each experiment may be traced when the record is reproduced.

If a piano is used (and all musical records are vastly improved by a piano accompaniment), it should be an upright, with the back of the instrument as close to the horn as the position of the performer will permit. This again is a matter of judgment, as some pianos are so much louder than others that they may be placed farther away, up to three or four feet. With a square or a grand piano, it is difficult to get real good results unless the cover of the instrument is raised at an angle (so as to act as a sounding board), and the horn placed very close. For vocal duets and quartettes, the singers should stand with their heads as close together as possible, directly in front of the horn. Good records of choruses are not easily made, as the greater the number of singers, the more complicated do the sound waves become. In fact, a single voice or a single instrument will produce every time the loudest record. The cornet is the best instrument for the amateur to commence with; it should be placed from four to six feet away. Watch the high notes carefully, or the record will blast. The scheme of "flagging," high notes is a good one. Whenever such high notes are played, lower a silk handkerchief in front of the horn. But better still, have the player enter into intelligent co-operation with your efforts, and by repressing certain notes, he can aid you very materially. The most successful Phonograph singers or performers are those who watch results as carefully as the record maker does himself and regulate their efforts accordingly. They must realize every moment that they are making records for the Phonograph, and not singing for an audience. Evenness of tone is what tells.

A piccolo or a clarinet should be within a foot of the recording horn. A violin or banjo as close as possible. Banjo duets make especially loud and clear records. A guitar or mandolin does not give satisfactory results. A xylophone should also be as near as possible, with the upper octave closer to the horn than the lower.

In making band or orchestra records, place the bass instruments, (such as tubas, altos and trombones) at a distance of five feet from the horn. These instruments all give tones having slow vibrations, and consequently must be nearer the recording diaphragm to balance the other instruments having a greater energy of tone vibrations. Cornets should be at the greatest distance,

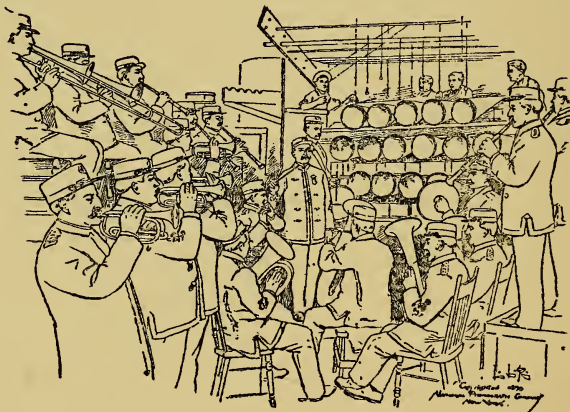

about fifteen feet. Place the other instruments in between ; piccolo, five or six feet from horn ; clarinet, seven feet. Better omit the bass drum. It is likely to spoil the effect, as it does not record well. If it is possible, have the cornets on the back row well elevated, so that the performers in front do not cut off or block the sound. In fact, it is well to elevate even the piano

about two and one-half to three feet from the floor, so that it may be on a level with the recording horn, which, as before stated, points level with a singer's head. For record making at home, where it would not be an easy matter to do this, the performers should sit rather than stand, so that the piano accompaniment records with a true relative value to whatever it accompanies.

As previously stated, *experience* in the art of record making is the best teacher. The above instructions merely outline the principal points to be observed. Follow them carefully, and give particular attention to the minutest details, as very frequently the smallest trifle will spoil what would be otherwise a highly satisfactory record.

CHAPTER IV.

THE PHONOGRAPH AS AN AID TO LANGUAGE STUDY.

THERE are two ways of learning a language. One, the University method of studying from a literary standpoint ; learning the grammar, learning to read but not learning to speak ; in other words, *through the eye*.

The other way is *through the ear* ; the natural method. Mark Twain has told us what a wonderful country France is. " Why even the children speak French." This sage reflection, however, does not avail those of us who, though fortunate in being born Americans, yet wish to speak the tongue of Johnny Crapaud with pure native accent. So, unless we go to Paris, we rely on a teacher, whose excellence of method and accent shall prove either our making or undoing as the case may be.

The conversational system is generally conceded to be the best ; yet some teachers carry out this idea so far as to claim not to teach the grammar. Both methods have their advantages and weaknesses. The two methods may be combined by the use of the Phonograph, in such a way as to learn the grammar at the same time while learning to speak by hearing the Phonograph speak. This is really the ideal method.

Every one knows that the secret of learning to speak in foreign tongues is to hear the language constantly spoken. The way to learn French, is to " go to Paris." The next best thing

is to have a teacher constantly with you, to talk whenever you desire and say just what you wish to hear, repeating as many times as wanted and no more ; a teacher that never gets tired and does not have to be paid.

The great adaptability of the Phonograph for this sort of work is readily apparent to any person understanding the machine.

In learning any new subject, art, science or business, particularly languages, it is always a matter of surprise to consider the small number of leading principles constituting the frame-work of the entire subject. When these principles are acquired, the whole subject becomes an open book. This idea is strictly illustrated in language study. A vocabulary of 1000 to 2000 words is sufficient to cover all ordinary intercourse. A few ordinary pages will contain all these words and they will go on eight Phonograph cylinders, allowing 250 words to each cylinder. If these are placed on a Phonograph and run across consecutively, without stopping, it would only require about half an hour to hear them all. Think of it ; all the words that you would require to know of any foreign language could be spoken in half an hour.

But, these words cannot be learned by rote. They must be learned in combinations of sentences, with changes in construction, according to their grammatical connection. The best way to learn them is undoubtedly to hear them spoken constantly in these combinations.

Take any lesson from any language text-book, for example, French, German or Spanish ; let the reading or conversation exercise in the foreign tongue be dictated to the Phonograph by a *native* voice.

If the pupil is studying with a teacher, so much the better. Now after the lesson is over, and the teacher has dictated the lesson, let the pupil go home and listen to that cylinder before he retires, listen several times, until he gets tired. Then, the first thing next morning upon rising, start the Phonograph talking and let it talk while dressing,—killing two birds with one stone.

He can listen to that record seven or eight times in the morning, without apparently consuming any time. Let him take another lesson in French from the Phonograph when he comes home at night, two or three turns of the cylinder whenever he has the opportunity. Every word on that cylinder will, in a remarkably short time, be committed to memory and so indelibly stamped upon the mind that it becomes like his native tongue. He can soon reproduce in the exact tone of voice, accent and inflection of the machine—and what the machine teaches him will be a faithful reproduction of what the teacher has spoken into it, without the slightest variation from his pronunciation. This is simply an ideal method.

Let the pupil take three or four pages of conversation in this manner and listen to it daily between lessons, repeating it over after the machine, imitating the accent given by the machine. When he goes for the next lesson the teacher will be surprised at the readiness with which those sentences will flow from the pupil's lips.

Having learned the words in those sentences, it is an easy matter to adapt them to other sentences.

Any teacher of languages can put the lessons from any textbook upon the machine in this manner, for the benefit of the pupil. Of course, it is better if a special book is used, prepared by a teacher who has given thought to this method of study. There is prominent Professor in New York, who has done this. He has been using the Phonograph in teaching French and Spanish for the past ten years. Both his Spanish and his French books are designed for this purpose and all his teaching is done in this manner. Pupils use his book, who do not use the machine, but if they desire to use the machine in connection with it, there is the book and the system already prepared. The Professor furnishes cylinders in Spanish dictated in his own voice. In French the cylinders are dictated by a native Frenchman. 20 lessons comprise the course, covering all that is contained in the book.

When a student can talk fluently everything that is upon the Phonograph in those twenty lessons, he knows enough of the language for all ordinary purposes. By having these records and a machine in his own home it is only a question of listening to them all, faithfully for a short while, until they will be learned.

The pupil sits at the Phonograph with the open book before him. He sees just what the word is, printed in foreign tongue, with the English translation underneath it. He has previously read or studied what the book says about the pronunciation of the letters, accents, the construction of the sentence and the grammatical form. Then, having these things in his mind, he listens to the sounds by hearing the machine speak them. Thus he cultivates the eye and ear at the same time. Then he imitates the machine and tries to pronounce the letters and the words exactly as the machine pronounced them. He is not afraid to say them over as many times as he wishes, or to make the machine go back and repeat, many, many times, oftener than a teacher would be willing or able to repeat for him.

Suppose a student wishes to study several languages. He can have a set of French records, a set in Spanish and a set in German, or in any other language, all at the same time. Having purchased the cylinders and the machine, there is no further expense attached to it and the student can prosecute his studies to any length, at his own pleasure.

Nor is there the slightest difficulty in acquiring all the most difficult sounds in any of these languages. The German "ich" and the French nasals, reproduce perfectly. Take the word "marche" in French, m-a-r-r-r-ch (pronounced like sh). The breath sound of ch, surprising as it may seem, can be reproduced, if properly dictated, so that it will be heard through a large horn, clear across a large room.

Let a German teacher, with a full heavy voice, dictate to the Phonograph "Mein Kind, ich habe nicht daran gedacht," and the German guttural will be heard distinctly. The writer has a

French cylinder which begins, "Monsieur Robert, est-il chez lui? Non, monsieur, il est sorti. Ou étiez vous hier? Hier soir j'étais au concert. Combien d'argent avez vous dans votre portmonnaie?" These sentences soon became so fixed upon his mind from constant Phonograph repetitions, that he could hear them ringing in his ears whenever the idea of French occurred to him. After a few days, about two pages of conversation contained on the first cylinder, could be repeated understandingly and with the exact accent as given by the Phonograph, which had been previously talked into by a French teacher. This could not have been done in as many months with any ordinary method of teaching. French teachers will all admit that many times they have pupils who study with them for years and yet cannot speak.

Say there are two hundred words made up into sentences on one cylinder. It takes about four minutes for a cylinder to run through. Now, if those sentences are listened to over and over again, with the eyes on the printed book, following every word as the machine speaks it, no better practice could be imagined. It is far better than the disconnected practice obtained in conversation with persons, many of whose words are not comprehended. It is useless to listen to talk in a foreign tongue, where the pronunciation is not understood and the meaning is a total blank. One-half hour's practice listening to the Phonograph and studying out the meaning from the printed translation accompanying it, also learning the rules of construction as laid down in the text books is worth more than a whole evening spent in disconnected conversations.

Take a single sentence, for instance "Yo deseo hablar espanol." Repeat that sentence alone, many times, until every single sound and inflection is perfectly clear to the mind. Then turn to the grammatical rules given in the same lesson of the book and learn the reason for everything which is being listened to. After that is thoroughly learned, so that the student not only understands the construction but can also repeat the full sentence

without the aid of either book or Phonograph, then let him take the next sentence. When that is learned proceed to the next and so on, until all are learned. Then let him start at the beginning and repeat the first sentence, then the second, then the third—until he makes a mistake; then go back to the beginning again and repeat from the beginning. Let him practice this until he can repeat the entire contents of that cylinder from memory.

The pupil will thus commence from the beginning to acquire a special vocabulary, which, can be learned by no other way, except by years of toil and perhaps waiting for the opportunity when he can go to Paris, or to Cuba, only to find when he arrives there, that he belongs to that class of Americans who, it is said, although they study French in this country, cannot speak or understand a word of what is said to them on their arrival in Paris.

The writer firmly believes that any one with a taste for languages can learn three languages in his own home, with the aid of a Phonograph easier than he can learn one without the aid of the instrument. An earnest student can learn without the aid of a teacher. Of course, it is better to have a teacher too—but much can be learned without a teacher, there is no doubt about that. If he could not have both—a teacher and a Phonograph, and had to choose between them, the writer would certainly take the Phonograph.

CHAPTER V.

THE PHONOGRAPH AS AN AID TO THE ARTS OF STENOGRAPHY AND TYPEWRITING.

Being a conversation and argument between Charles Freeman Johnson (a shorthand reporter of considerable fame and prowess) and Mr. Openeer.

“**J**OHNSON,” said I one day, “you’re a hard headed practical business man ; what do you think of the Phonograph in every day business? It is an acknowledged factor as a home entertainer ; but what do you *know* about the Phonograph for practical business use?”

“Mr. Openeer,” he replied, “I know a lot about it ; I’ve been a shorthand reporter for twenty years.”

Now, my friend Mr. Johnson isn’t much of a talker ; his business is listening ; and he does a lot of it, (all the time writing while other fellows are talking). So I said, in a bantering way, to draw him out, “Do you really think—”

“Do I think,” he grew hot right away, “Do I think it’s of any use? After using it for ten years in my business? After training hundreds of operators to earn their bread and butter by it? After seeing our court stenographers earning big money by reporting cases with its amanuensis aid, which they could not otherwise report without calling in the aid of other stenographers?” He paused for want of breath.

“Say, Johnson,” said I, “don’t talk to me at the rate of 250 a minute ; come down to 132 and tell me about it in a kindly and christianlike manner.”

“No I don’t think,” he went on again ignoring my interruption, “I don’t think the sun shines or the wind blows or that it rains or snows. I *know* these things absolutely, and I also know absolutely that the Phonograph in its sphere is just as important a factor as the telegraph, the telephone, the typewriter and the stenographer are in theirs. The time was when no telephones were used, and not so very long ago there was no telegraph and no typewriters, and a stenographer was a rarity ; now, we have all these things and we also have the Phonograph.”

When Mr. Johnson warms up, he is really quite eloquent.

“Johnson,” said I, “How does a typewriter come in on the Phonograph question.”

“An operator becomes more expert through practicing from Phonograph dictation ; just as shorthand students train themselves for the fastest shorthand reporting, by taking down shorthand exercises from Phonograph dictation.” He whipped a letter from his pocket. “Listen to this,” he said.

MY DEAR MR. JOHNSON :—

When I wrote you last fall, I was thinking about buying a Phonograph to be used as a dictator : in this way ; you see I am a stenographer, with a speed of 140 words a minute ; my object is to increase my shorthand speed, so all I now need is some one to read to me. My work being of such a nature, I cannot get anybody to read to me in the day, and when I get home at night it is too late to have a person read to me even at a reasonable price, should I hire one. So the idea came to me to get a Phonograph.

Now I want to ask you a few questions concerning the Edison Home Phonograph, as that is the one I shall buy, the one for thirty dollars.

Will it record my voice in such a manner that on being reproduced I can write it down in shorthand just as though a person were reading to me? Will every word be reproduced distinctly

provided it is dictated distinctly? If for instance, I take a clipping from a newspaper containing about one thousand words and dictate the same to the Phonograph at a rate of 180 words per minute; could I make the Phonograph reproduce it at a rate of 190 words and also at a less rate? In other words, can I make the Phonograph reproduce the same record very fast or very slow; and while being reproduced fast, can it be heard as distinctly as when reproduced slow, and also *vice versa*?

How many times will I be able to use the same record, and how many times can a record be shaved and a new record taken? Please tell me what size horn I shall buy. Can I dictate through a horn or is it necessary to use a speaking tube?

If the Phonograph can do as above asked, I want you to buy me one.

Yours very truly,

Johnson folded this letter up and put it back in his pocket with a satisfied air. "I answered this letter," he said, "and told him that he couldn't do better than to buy a Phonograph right away, as it would do all he asked and more too. He can get 800 to 1000 words on a record, and can reshave it a hundred times if he's careful about it.

"That is certainly very much to the point," said I, "and now what else do you know."

"I was stenographer in the famous Fair will case in San Francisco, probably one of the greatest cases ever tried in this country, lasting over five months. I saw page after page of daily testimony and arguments forming an exact copy of the complete proceedings ready by 9 o'clock the same night; thousands of pages in all, so that the judge and attorneys had the complete proceedings of each preceding day before them upon starting work every morning. All this was done by one shorthand reporter, (your

humble servant), and two typewriters with the aid of the Phonograph in transcribing.

“I also reported the proceedings of the Trans-Mississippi Congress in 1894, both in St. Louis and in San Francisco; the California Fruit Growers Association in Los Angeles in 1893, the American Publishing Association in Brooklyn in 1889 and the National Trotting Association, held in Buffalo in 1889; and many others. So I guess you'll believe that I know what I am talking about.

“Every person, no matter how ignorant, understands that it will require time to learn to become a good telegraph operator, and it takes many months and years to become a good stenographer, and it seems funny that they should not think the same way about the Phonograph.

“Why should we spend time and money to learn telegraphy, shorthand and typewriting and then have an idea that no time is required to learn the Phonograph; the most delicate of all and one of the most useful.

“The use of the Phonograph must be learned, the same as anything else. But how easy it is to learn, and to use, when you know how. Take the easiest of all the foregoing arts, typewriting. Even that requires weeks to learn; and months, perhaps years, to become expert. But the Phonograph, while it does require a little time to learn, yet needs but a few days to learn *everything* about it and only a few weeks practice to acquire *all* the dexterity in its use, that is necessary to make it an indispensable adjunct to a skilful person's life. Yes, indispensable to life; for life is not worth living without it to a man who really has much business requiring its use. I make the following broad statement without the slightest hesitation.

“Every person engaged in work of any kind requiring dictation and typewriter transcription, can do this work with greater ease by dictating to the Phonograph than in any other manner.”

“Do you mean that the Phonograph will entirely take the place of shorthand,” said I.

“No, nothing of the kind,” replied Johnson, “I believe that not in a thousand years will this ever happen. There are many cases where the dictation (from the circumstances of the case) can be done better in shorthand. For this reason the amanuensis stenographer will never be entirely displaced. The telegraph has not been displaced by the telephone; the elevated railroads have not displaced the surface lines, nor has the typewriter done away with handwriting. More pens are manufactured today than ever before in the world’s history. The greatest usefulness of the Phonograph for business purposes, lies in its value as an aid in developing shorthand and typewriting. It will make more work and increase the number of typewritists and make better operators of those who use it in their daily work, or in their practice as students. In many cases perhaps, it will take the place of the amanuensis stenographer, as any good typewriter can do all the necessary work from it without the aid of any shorthand whatever. But the same person doing the amanuensis stenography, will become the phonographist, receiving more pay, for an expert phonographist and typewritist is worth more pay any time than an ordinary amanuensis stenographer. While it should increase the wages of the typewritist, it will save money for the employer, for far more work will be done by each operator.

“It should be a part of every stenographer’s education to understand the Phonograph thoroughly, to be able to dictate his notes, and, if a typewritist, to be able to transcribe from it. He should know everything pertaining to his art. The time is certainly coming when thousands of Phonographs will be in use; when the sight of a Phonograph in a business office will be as familiar as the sight of a typewriting machine.

“There are 3,000 business colleges and shorthand schools in the United States, averaging say 150,000 students of shorthand and typewriting. A large percentage of these will never pass the

line of mediocrity, because they have not the general education and special talent required to make good stenographers. Yet all of these could become good typewriters and fill money earning positions, simply by learning the use of the Phonograph. With three months' study, they could take positions. If they wish to learn shorthand besides, they can get all the dictation practice so necessary, by writing down in shorthand selected dictation exercises previously dictated to the Phonograph. And it is so much easier for this sort of work to be done from the Phonograph, that it will ultimately result in its being done in this manner, as soon as the public and the operators find out how much better it is.

“Every student of shorthand should own one of these machines and have it in his own house for practicing shorthand dictation. It is far better than a human dictator. If the student asks a sister, or brother, or a friend to read for him, they soon tire out. Besides, the best of reading for practice is never quite satisfactory. But with a Phonograph, the student dictates any of the exercises he wishes to practice, at his own rate of speed; then lets the machine talk it back to him at whatever rate of speed he may choose and he practices taking it down in shorthand, over and over again, as many times as he wishes, until he becomes thoroughly expert.

“The secret of speed in shorthand writing is constant practice on the same exercise, writing a paragraph over and over again, until it becomes almost second nature to write it. For this purpose, a Phonograph is simply ideal; and it will not be long before every business college and shorthand school in this country will have an equipment of Phonographs for the purpose of giving their scholars dictation work, instead of paying teachers salaries for the purpose of reading dictation exercises to scholars, as they now do.

“Now let us come to the question of what class of people needs the machine *most*, and who can use it the most readily. I

answer, court stenographers. Why? Because, they have the most work of this kind to do. How do they do it? Well, they report in court all day long, we will say. A reporter takes from 100 to 200 pages of shorthand notes a day. When court adjourns, he goes to his office and reads his notes into the Phonograph. He simply talks them off from his note book, just as fast as he can possibly talk. It makes no difference to the typewritist how fast the dictator talks into the machine. He can try his skill in this direction and talk 'like lightning.' As soon as the cylinder is full, it is turned over to the typewritist, who is waiting with another Phonograph and a typewriter. The reporter goes right on dictating another cylinder, as fast as he can talk. The typewritist meanwhile starts the first cylinder on her Phonograph talking back to her. If too fast, she simply stops the machine until she catches up; then she goes ahead again; or she can set it back and repeat as many times as necessary.

"With a good typewritist, no repeating is necessary, for the reason that the reproduction can be regulated so that the talk will come off, not as fast as dictated, but at a very slow rate of speed. In this way an expert typewritist can keep writing continuously, without making any stops, all the time keeping up with the machine.

"This develops great speed in typewriting; and it is the experience of all operators using the Phonograph (until they become thoroughly expert with it), that they prefer writing in this manner. They can turn out more copy than in any other way, with more ease and comfort to themselves.

"Every typewritist knows how much pleasanter it is to write from dictation than either from copying or from shorthand notes. One half of the transcriber's time is wasted in deciphering notes. An expert transcriber from dictation can do as high as eighteen pages an hour, while the same operator, transcribing from shorthand notes, could not do more than ten pages an hour. This, of course, is the highest degree of skill.

“With the Phonograph, the typewritist is not compelled to adapt her time to the reporter’s, and it is a wonderful relief to him to know he can stop work at any moment, without wasting the time of another employee, in the middle of a sentence, or at the end, and go on again from the same place, whenever he is ready. He can be doing something else, while his work is being transcribed, releasing him from the drudgery of being tied down to the operator, waiting for the slower transcription; when he knows he could talk so much faster.

“In dictating to an amanuensis stenographer, the time of the employee in taking notes is entirely wasted, for if the dictator were talking to the machine instead, the amanuensis would be engaged in transcribing something else, or doing other work. In other words, the Phonograph gives both dictator and transcriber absolute liberty as to time.

“If reporters can do this with the Phonograph, ‘because they have so much of it to do,’ how much easier it should be for other persons to use it, who have less work to do?

“Not only is the Phonograph a benefit to the typewritist, but it is an educator to the person dictating. It will improve the dictation of anyone using it. There are lawyers whose speeches at the bar are models of diction; not requiring the slightest change after delivery. But there are many others, if their speeches were reported word for word as delivered, who would deny they ever uttered them. To such men, the habit of dictating to a Phonograph would be invaluable; for it would force them to think, before beginning to talk; to put their language in proper form for expression and not leave the auditor to imagine from their disconnected words what they really mean to say.”

“As far as the talking quality of the Phonograph is concerned, it is to-day perfectly satisfactory. If the cylinder is properly shaved so as to present a smooth and highly polished surface, and the record is properly dictated, in the right tone of voice, with the mouth at a proper distance from the speaking

tube, the reproduction will be perfect. It will be so clear that no one can have the slightest difficulty in understanding it, quite as well as if spoken in the ordinary manner.

Dictating correctly, without mistakes or changes, is entirely a matter of habit. With a little practice a dictator can form the words in his mind, so as to utter them rapidly, without correction. Should an error be made, it can be indicated to the typewritist before it is written, by simply saying at once, 'mistake.' If a change is required in matter dictated some time previously, it can be made readily by a simple memorandum on the slip of paper used to number the cylinder, calling the typewritist's attention to the same. The typewritist, seeing the memorandum, will catch the change before commencing to write, by listening for the part to be corrected.

"No judgment as to the usefulness of the talking machine for this work can be formed by listening to ordinary music, singing, or comic speech records. These give no idea of the clearness of reproduction for real work, with records properly made for the purpose. When dictation is carefully and properly done, pitch and timbre are in the record; the accent is clear and distinct; every change and inflection is noted, also the rise and fall of the voice; all in fact, that is required for reproduction of the work. Any typewritist with one week's practice in listening, can thereafter distinguish every word spoken to the machine, without the slightest difficulty.

"No one starting to use a Phonograph, should begin it without carefully considering every detail, having full instructions from those understanding it and having all the appliances necessary to make it a success. Where any failure is recorded, it is always due, not to any inherent inability in the machine for such work, but either to trifling mechanical defects, possible in any piece of machinery, or else to lack of intelligence on the part of either the dictator or the typewritist.

“ If the first trial of the Phonograph is not pleasing, try it again and persevere at it. It is like every new exercise. The first day of bicycle riding is unpleasant ; the first trial of skates on ice may be disastrous ; the first week of typewriting is very discouraging. But stick to it. Give the Phonograph a thorough trial of two weeks. Then, if you do not like it, you may rest assured it is only because you are doing something wrong and require a little instruction from some expert operator to show you where the difficulty is.

“ One machine is not enough ; there should be two. There must be a stock of cylinders, at least a dozen, and in a shorthand reporter’s office, as many as 150 cylinders should be on hand ready for use.

“ There should be a separate shaving machine and some one person trained to shave cylinders, whose duty it is to see that prepared cylinders are always ready for the dictator, standing in the proper receptacle alongside of the dictation machine.

“ The machine should be thoroughly and regularly cleaned, so as to require no attention by the dictator. Its running parts should be freed from wax and dirt daily, and carefully oiled.

“ The recorder and reproducer should be examined to see that they are in perfect order and should always be kept in receptacles provided for them, so that they are always ready when wanted and never broken by being laid down in unexpected places. With the best of care, the glass diaphragms are liable to be broken by accidents ; for this reason, it is well to keep an extra recorder and reproducer on hand for use, while a broken piece is being repaired.”

“ Make it a rule never to touch the outside, or talking surfaces of the cylinders with the hands, and never allow anything to strike them. Do not let the cylinders rub against one another.

“ Remember that the Phonograph, like the human voice, being designed to perform most delicate work, is a very delicate instrument, requiring the best of care and skilful handling, such

as any person of ordinary intelligence is able to give ; and that provided simply a little thoughtful attention is given to all its details, the results obtained are the most satisfactory and pleasing of all the devices introduced into the work-a-day life of the nineteenth century, for the aid of mankind in intellectual pursuits.

“ The best place for a typewritist to learn this work is in a shorthand reporter’s office, where there is plenty of work. The typewritist is then competent to fill any position where a talking machine is used. If such a typewritist, taking an interest in the work and thoroughly understanding the machine, will instruct the dictator how to use it (if not thoroughly conversant therewith), it will work with great satisfaction.”

“ A busy man’s time and brains now-a-days are worth too much for him to spend himself in the old ways of doing work, to say nothing of the saving of nerve power and physical energy, when a Phonograph can be obtained for such a reasonable sum. He can have a machine at his house and another, perhaps two, at his office. He can go home at night, sit in his own room in ease and comfort, and dictate at his leisure, taking the work to his office the next morning to be transcribed by the typewritist.

“ Many of the best shorthand reporters, all over the United States are now using this machine in their offices for transcribing their notes, and hundreds of the machines are in use in business houses where the heads of the various departments have learned to dictate their letters in that way, where they have long since passed the stage of experiment ; so that they now say, under no circumstances would they go back to the old way of correspondence by dictating in shorthand.

“ The time is coming when business and professional men will be ashamed to admit that they have not sufficient intelligence to dictate to the Phonograph, and when no typewritists or stenographers will consider their education complete without a thorough knowledge of the machine and skill in using it.”

CHAPTER VI.

THREE GREEK ROOTS.

φωνη = PHONE: the voice. Its use in such English words as telephone, phonetic, euphonious and megaphone, tells the story of its meaning.

γραφειν GRAPH: to write. As used in graphic, telegraph, and autograph, its meaning is clearly explained. Hence, PHONOGRAPH: the voice—to write. In other words, a device for writing or recording sound.

γραμμα GRAM: that which is written. As in the words grammar and telegram. Hence, PHONOGRAM: the voice—that which is written. That is to say, sound recorded; or, as applied to Mr. Edison's invention, a Phonograph Record.

ABOUT TALKING MACHINES IN GENERAL.

AT first there appears to be a wide choice when one decides to buy a Talking Machine. Besides the Phonograph (Thomas A. Edison's original invention), there are on the market a large variety of "grams," "graphs" and "phones," subsequent inventions or modifications of the Original Edison Phonograph. Not content with copying the general features of

the first Talking Machine, the names also for the various models are adapted from the titles chosen by Mr. Edison to describe the machine he invented and the record it made, of hitherto unseen sound waves. The result has been a confusion of names; and the public is to-day at a loss to know exactly what does, and what does not constitute a Phonograph, and a Phonogram or Record.

DIFFERENT TYPES OF TALKING MACHINES.

The most sweeping classification of Talking Machines would be :

The Phonograph (Class 1).

All other Talking Machines (Class 2).

This would not be just, however, in classifying as to types; for many well-known Talking Machines are very similar to the Phonograph in their general characteristics; the difference being mainly in their structural inferiority and consequent inability to do fine work.

As to types, therefore, there are but two Talking Machines—one using cylinders of wax or similar compositions, and the other, flat discs of hard fibre or metal.

With machines of the first type it is possible for any one to make a record, either of the voice, of musical instruments or, in fact, of any kind of sound. The waves of sound, playing upon a sensitive diaphragm, cause a sapphire stylus to engrave or indent upon the smooth wax cylinder indentations corresponding to the pitch or intensity of the sound. The cylinder revolves as the sound is continued, causing a succession of indentations to appear on the wax surface, in the shape of a long spiral groove. This constitutes a Phonogram—a “writing of sound”—a Record. When the sapphire point is set back at the beginning of the groove and the record revolves, it is vibrated by the indentations, making the sensitive diaphragm in turn to vibrate and to give off again the same sounds that caused the indentations.

With machines of the second type it is not possible to make records except with very elaborate and costly machinery, and the use of chemicals and acids. The groove is first traced on a flat disc by a stylus, vibrating sinuously, that is, sideways, instead of in-and-out as with machines of the first type. This groove is afterwards bitten deeper by the use of acids; thus destroying in a measure the absolute value of the sound writing. It is as if a child with a black blunt lead pencil should trace over the delicate strokes of a fine signature. The inaccuracies of the result are plain to the eye and ear. When the reproducing stylus is placed at the beginning of the groove and the disc is revolved, a harsh, grating sound is heard, in addition to the sound waves recorded. This is known as the "scratch of the needle" and is pronounced by musical experts to be a most radical objection; not taking into consideration even the fact that with this type of machine one cannot make his own records; which is more than one half the fun of owning a Talking Machine.

THE CHOICE OF A TALKING MACHINE.

That Talking Machine is best which is most complete. Viewed from the standpoint of absolute merit, the wax cylinder machines present the means for the widest enjoyment. With this type it is always possible for an amateur to make records, and they are superior in every way to the "flat disc" machine, with its gritty "scratch of the needle" and its acid-etched record.

With the complete wax cylinder Talking Machine, not only can records be reproduced that are especially prepared by experts in the art, but also records that are made at home. Not only are famous singers, bands, instrumental soloists, actors and vaudeville artists brought into your very home, but you have the enjoyment of making records of your own voice, your children's voices, your friend's banjo, cornet and piano playing.

With the choice thus narrowed down to complete machines of the wax cylinder type, there yet remain two considerations—Price and Quality.

It is a well known fact that the cheapest goods are not usually the best. A certain value must be asked for value given in manufacture. A dollar watch is made to sell. It is a good thing in its way, but for time-keeping it is a superfluity and a source of annoyance. A cheap bicycle is made to sell. It is a pretty thing to look at, but one buys a wheel to ride, not to put into a glass case. A cheap Talking Machine that is made *to sell* will make a noise ; its wheels will go around, but that is its limit.

It is also a well known fact that a great man with a great name and a great reputation, will use every power and exercise every care to uphold the high standard that the use of his name demands. There can be but one conclusion. To paraphrase the cry of Islam, “There is only one Talking Machine, and its name is the Phonograph.”

ALWAYS LOOK FOR THE TRADE MARK.

All Genuine Edison Phonographs bear the name of the inventor—Thomas A. Edison. That is the hall-mark of the genuine article. Other Talking Machines may look like the Phonograph ; may appear to run as true and as smooth as the Phonograph ; may even be called, unscrupulously, by the same name, but no one need be deceived.

The signature of Mr. Edison is on every Phonograph ; without it no other machine is genuine.

Phonographs are made with the delicacy and accuracy of a scientific instrument. They run smooth and true and govern perfectly. This explains their use by other companies in making fine high-priced musical records.

Edison Records are the best in the world. Not only is the best talent obtainable employed in the music-rooms at the Edison

Laboratory, but the records are made on Edison Blanks. This is a fact that speaks volumes to the Talking Machine expert.

Edison Blanks are chemically pure. They are recognized as Standard the world over.

They have no successful rival in the market. There is no Talking Machine company or infringer who does not recognize this fact and there are no records worth having that are not made on Edison Blanks. Other kinds are gritty, harsh and unserviceable, and little, if any, cheaper. The following, from a recent publication on the subject, covers the ground truthfully :

“While the ingredients that compose the Edison Cylinder are not unknown in the art, the secret of their chemical combination still remains with Mr. Edison. Other cylinders, made in imitation of his, and cast in the same form, lack the qualities essential for record making and other characteristics that give a cylinder permanent value.”

RECAPITULATION.

A Phonograph, any style, playing an Edison Record, any kind, made on an Edison Blank, is Perfection.

U⁵⁴ 3403

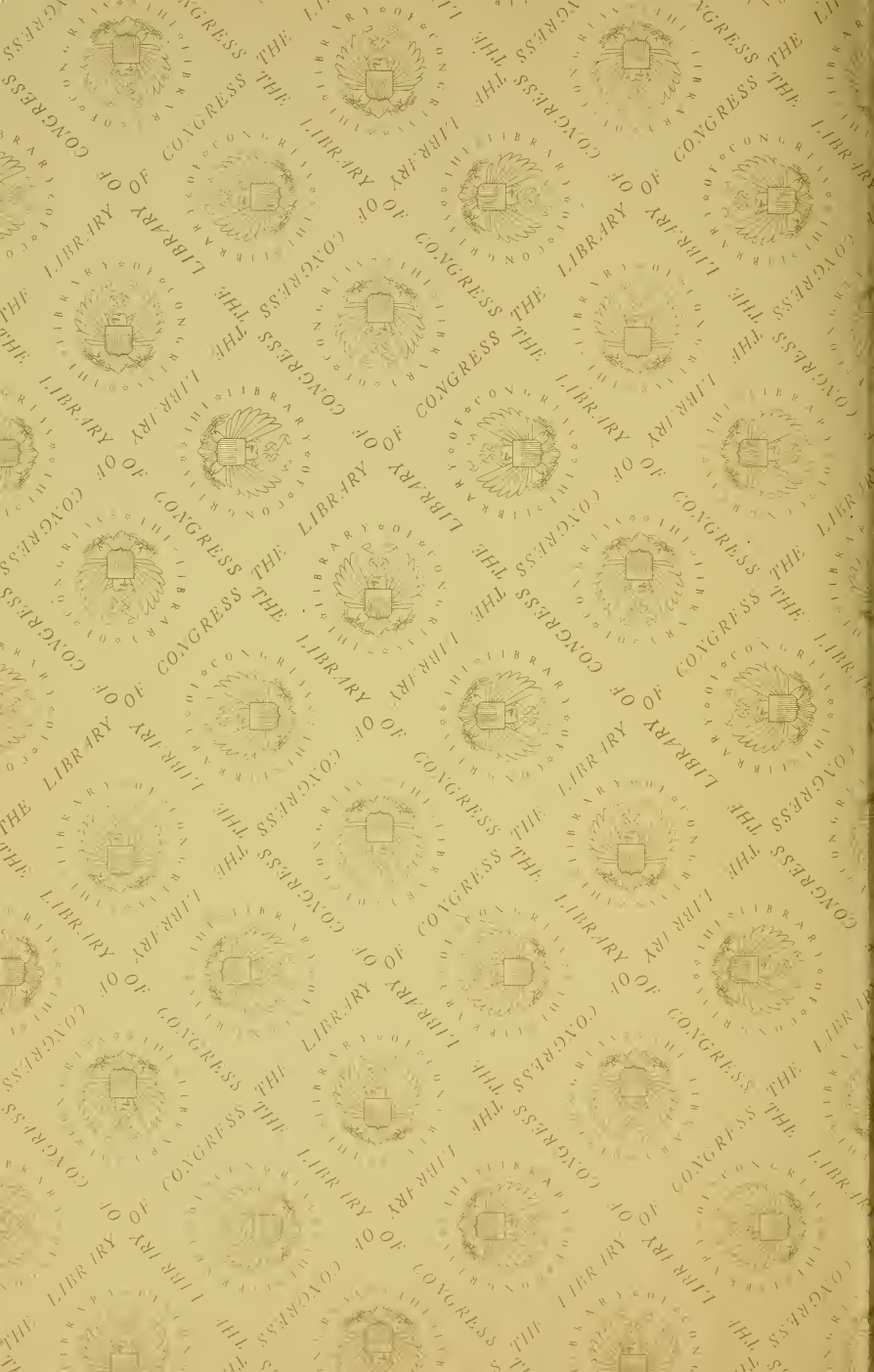

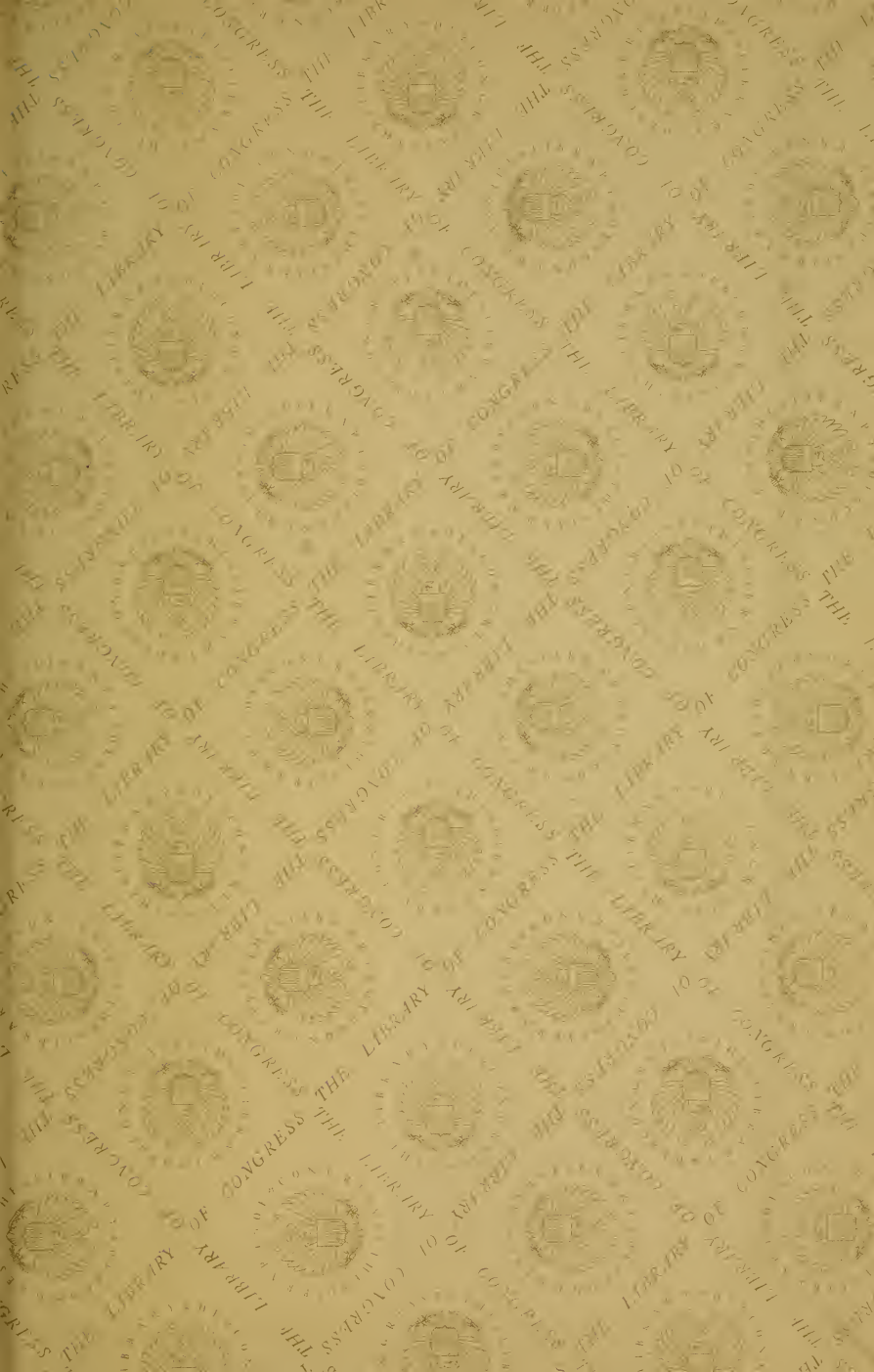

LIBRARY OF CONGRESS



00018784865

